

Anbau f. Malta 4
Art. Nr. 997800
1/7

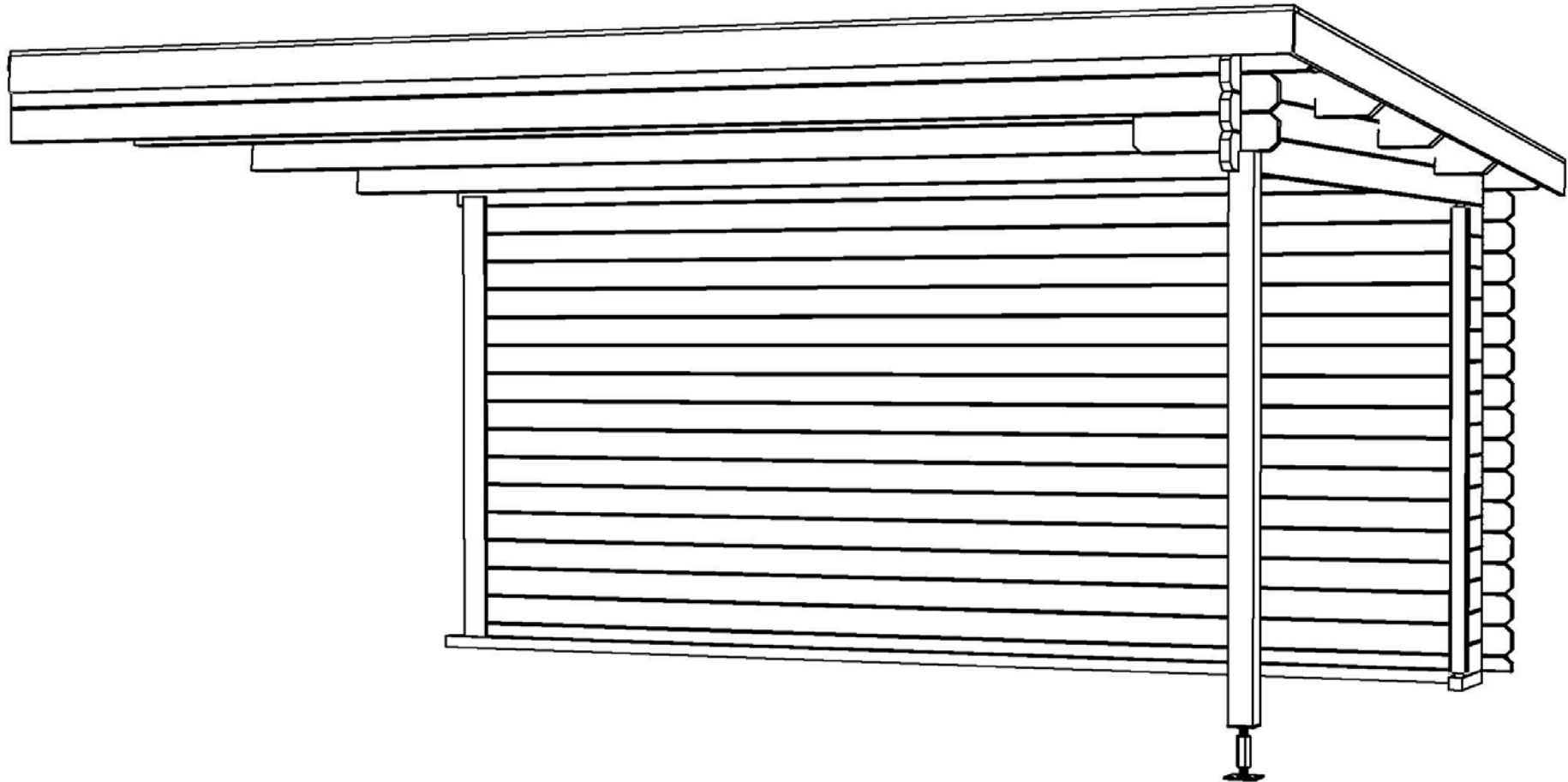

25.10.2018

Art. Nr. 997800

Grundplan - Grundplan - Plan de masse -
Planimetria - Plattegrond - Põhiplaan

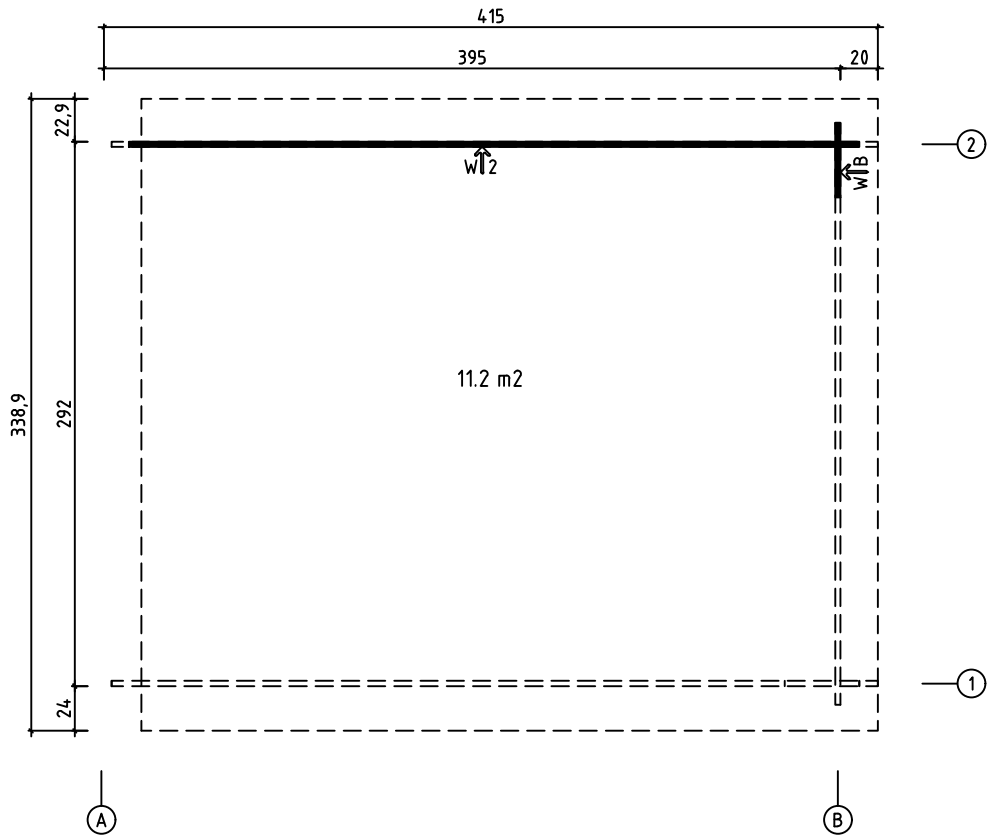

Foundation - Fundament - Fondation -
Fondamenta - Fundering - Immutatud alusraam

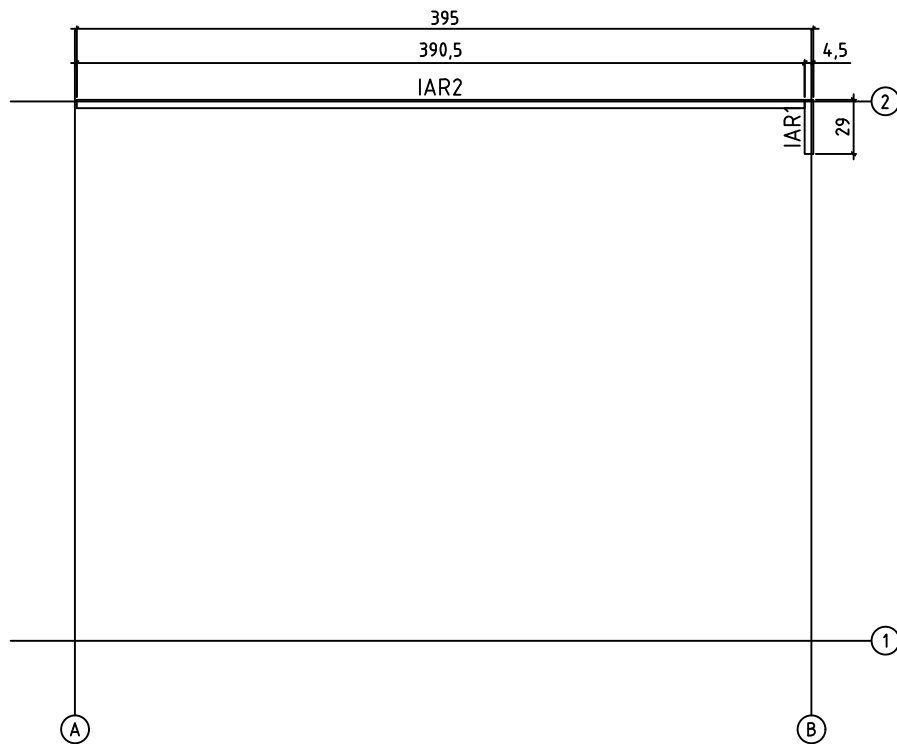

Art. Nr. 997800

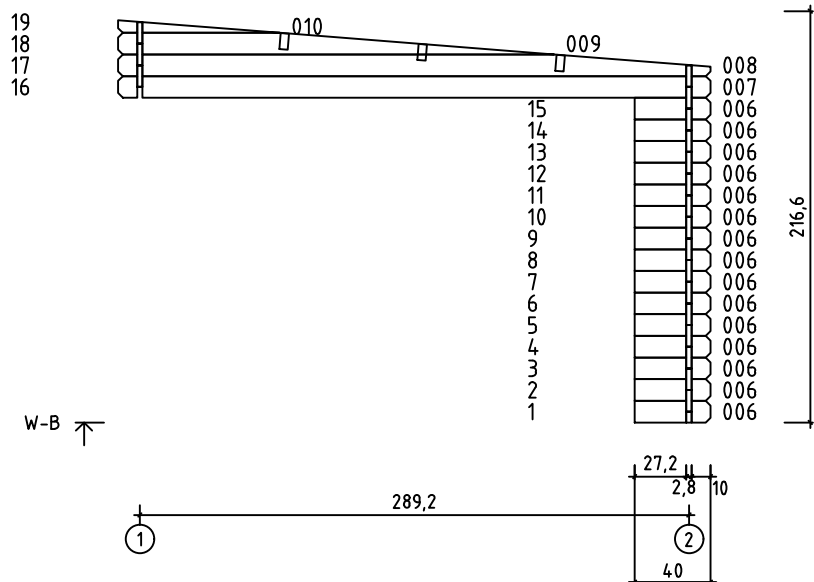
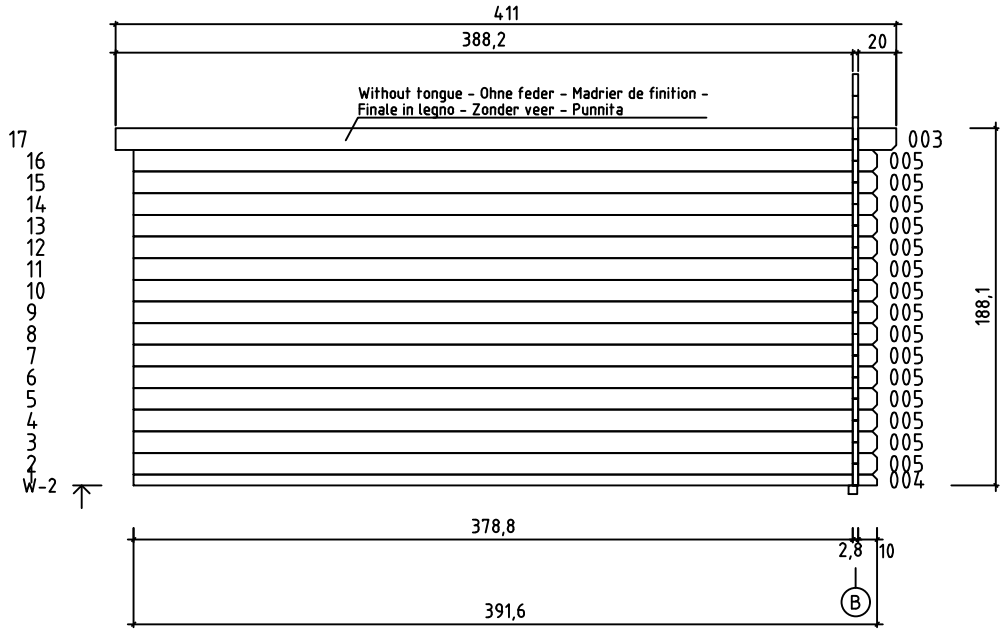
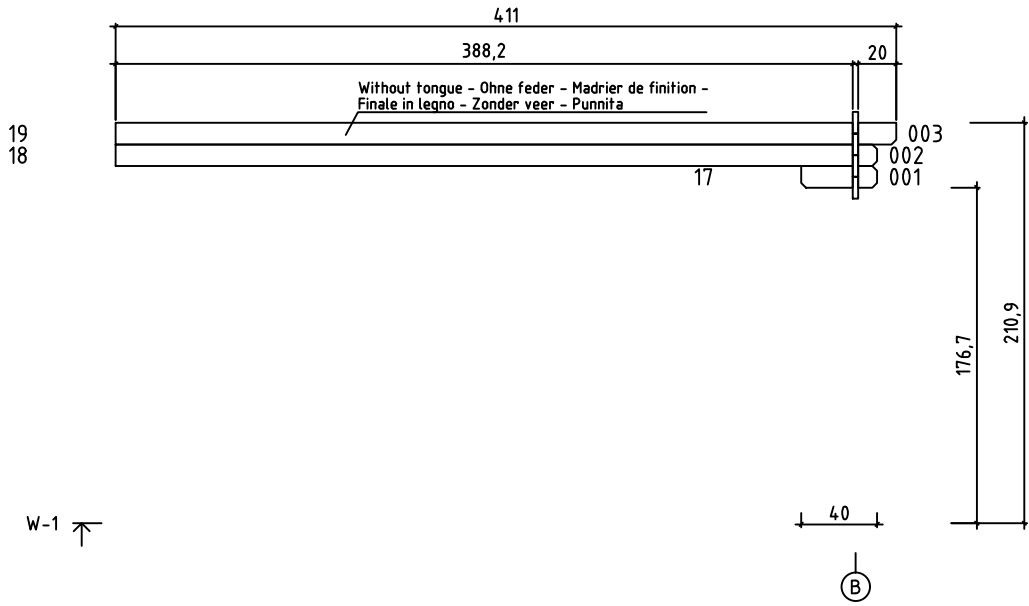

Art. Nr. 997800

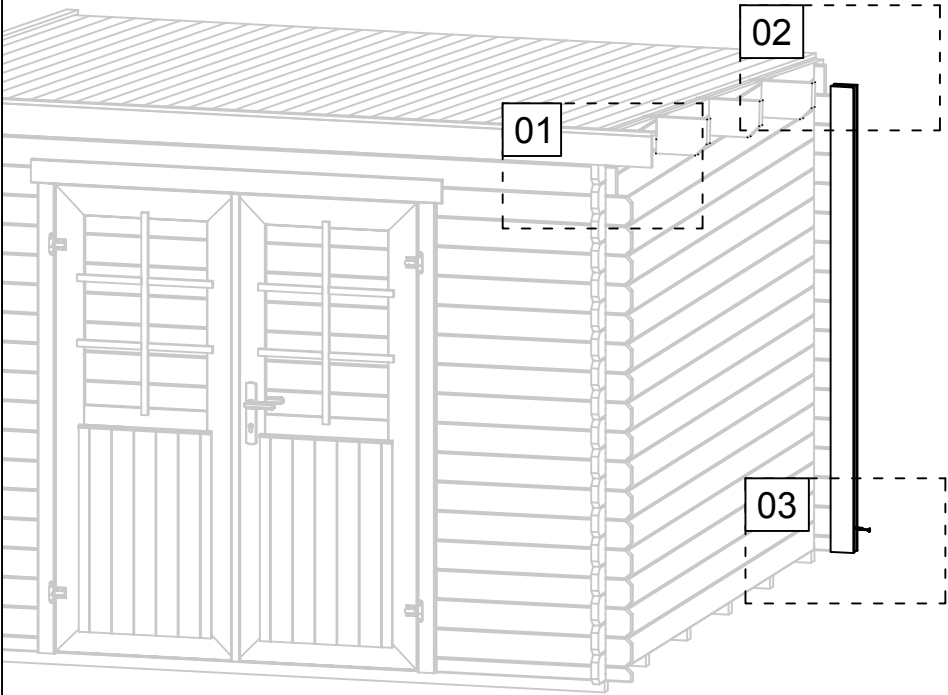

03

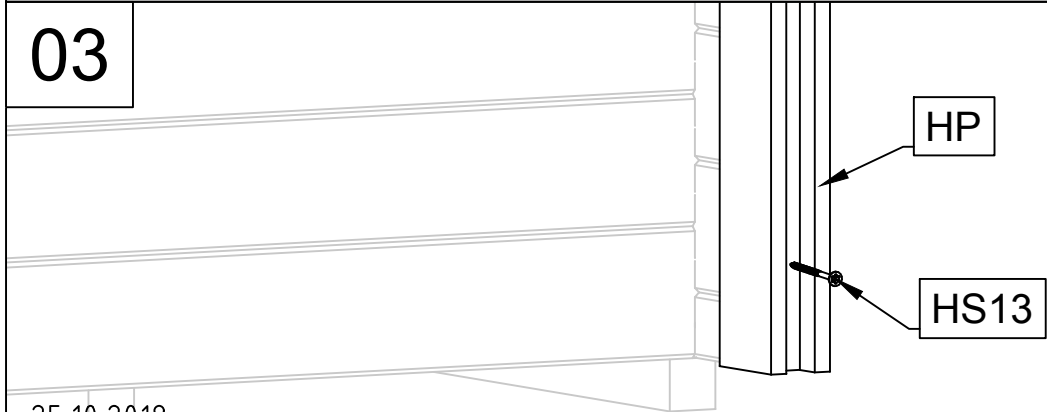

25.10.2018

01

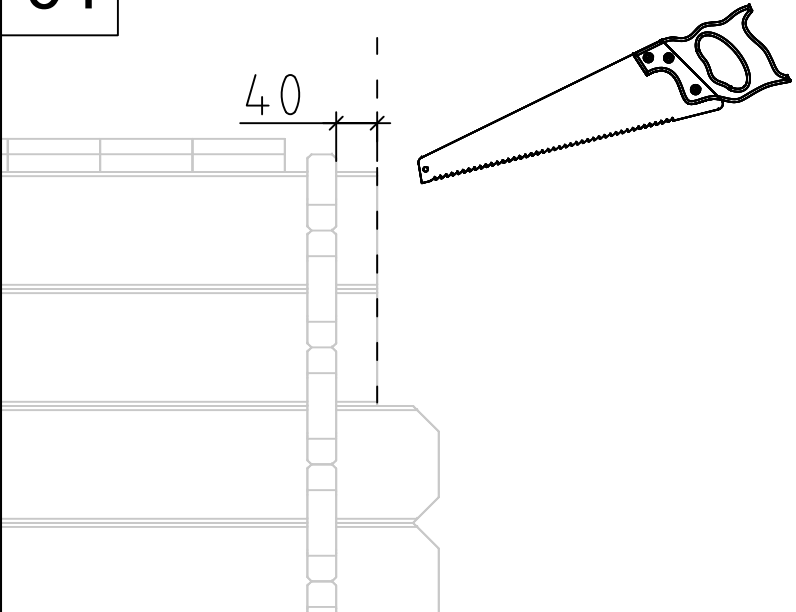

02

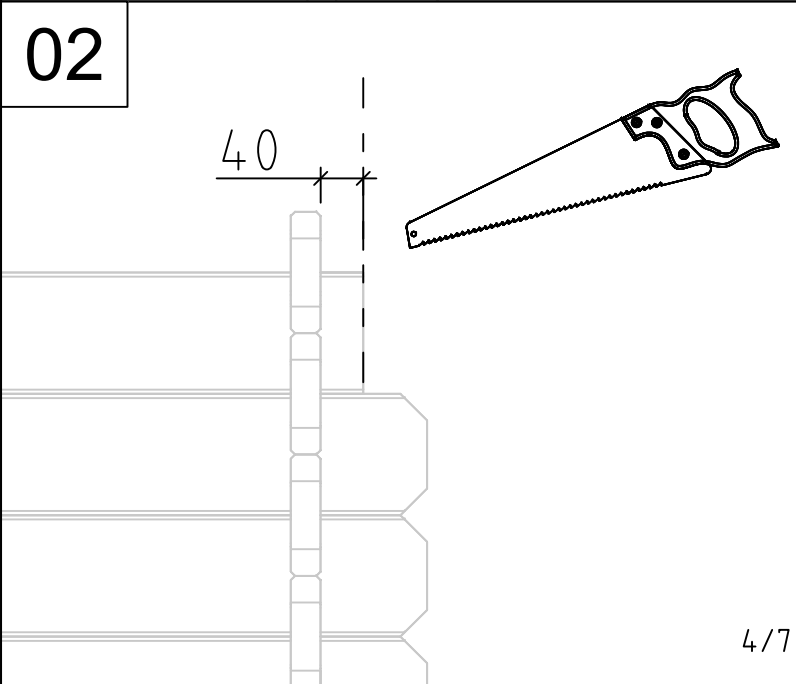





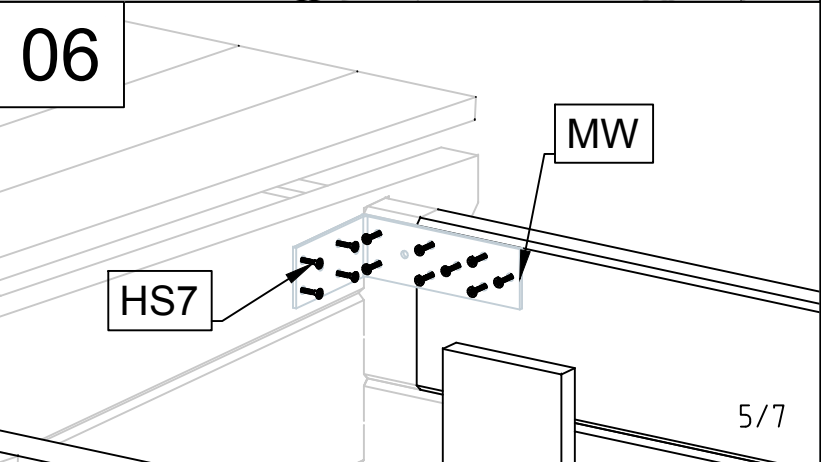
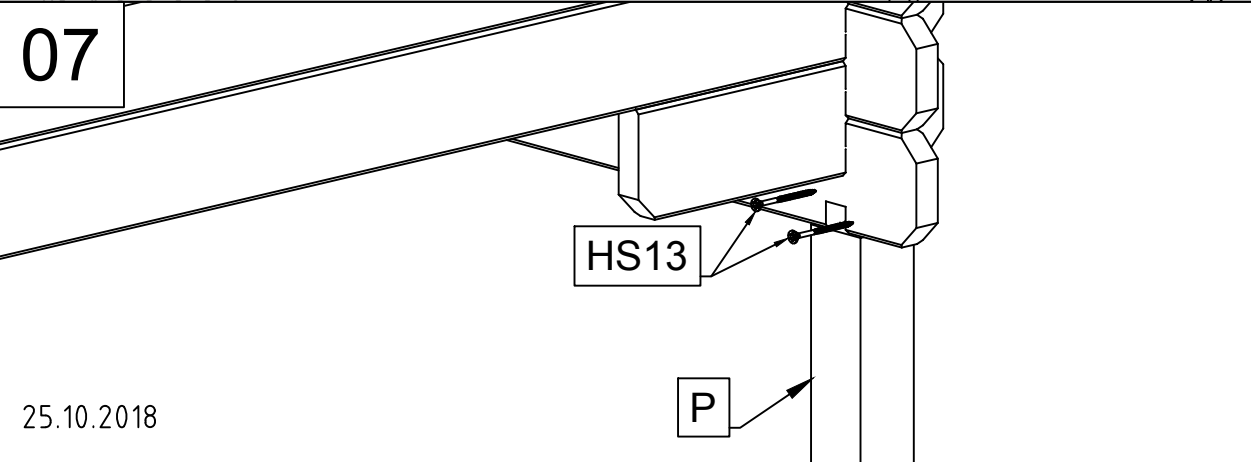
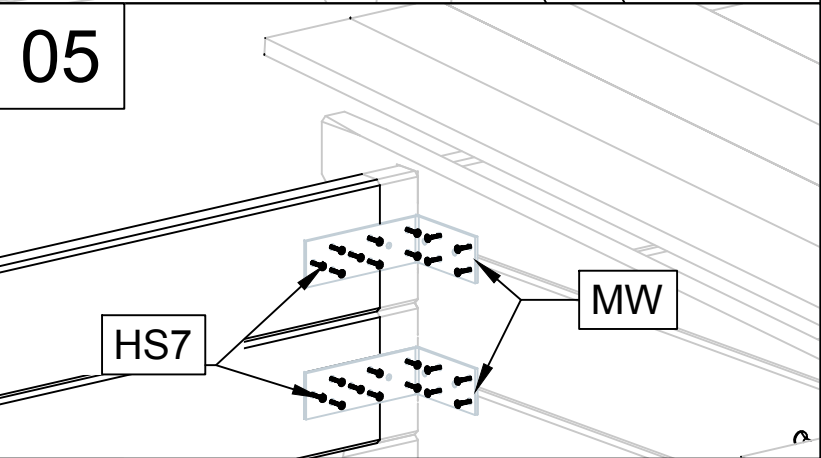
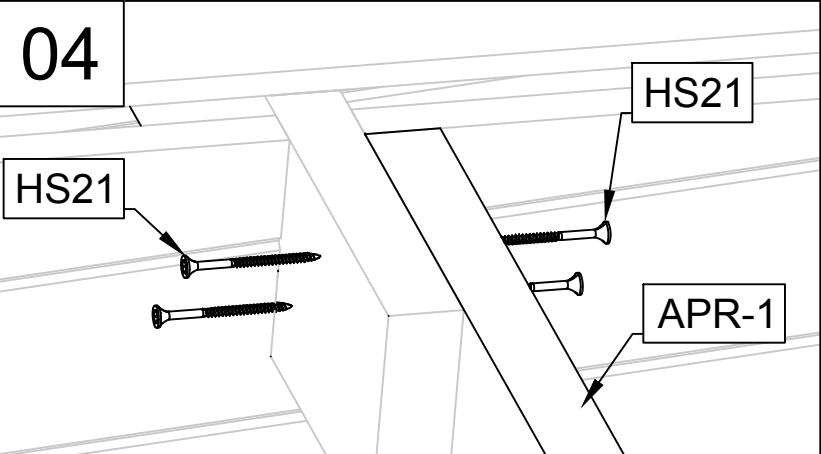
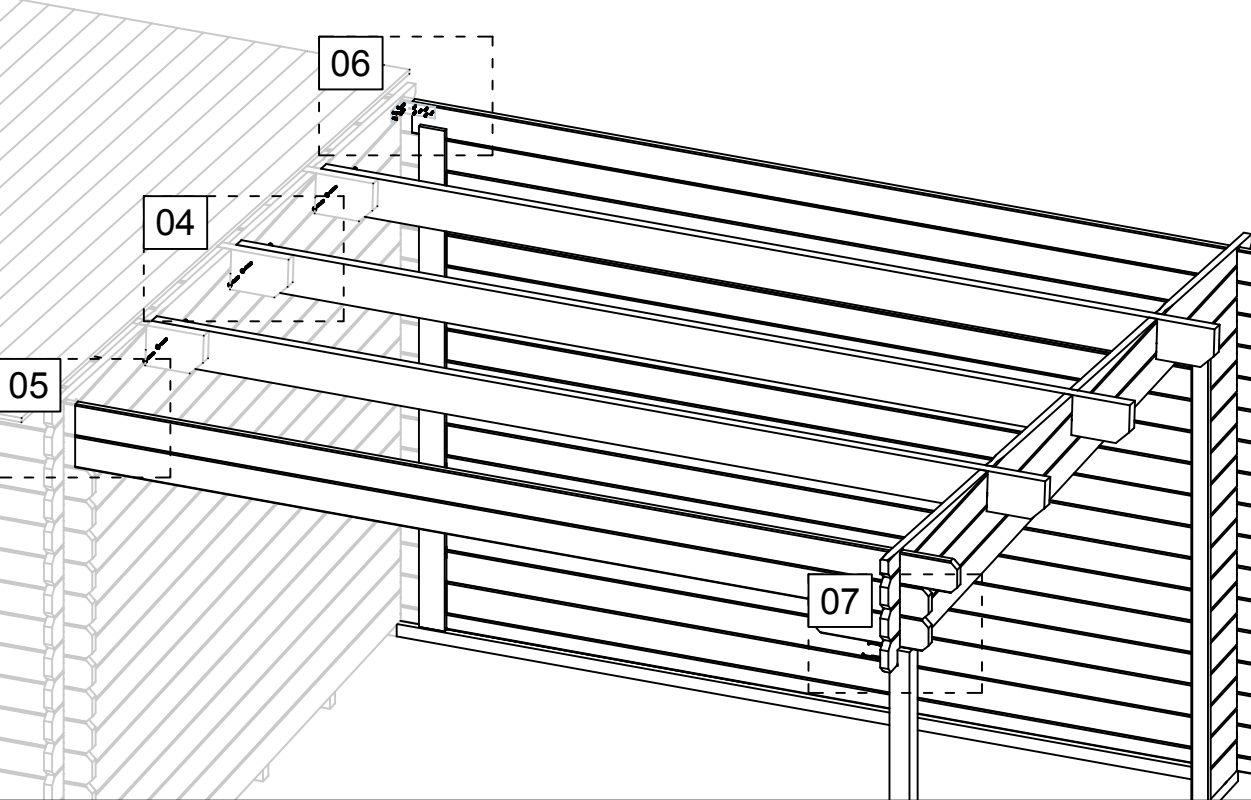





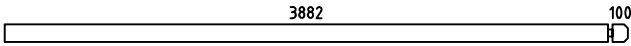
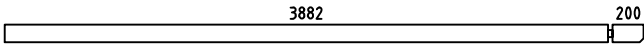
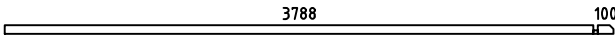
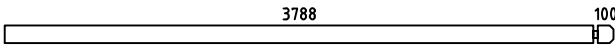

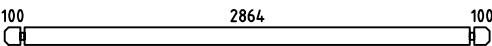
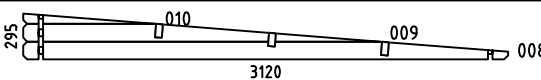
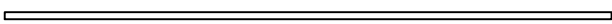

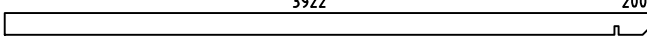
4/7

Art. Nr. 997800

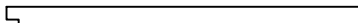

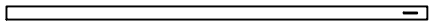
25.10.2018

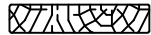
5/7

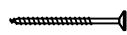
Pos	25.10.2018 Piece list - Stückliste - Liste des pièces - Elementi - Stuklijst - Tükitalabel Art. Nr. 997800 6/7	Q	P (mm)	L (mm)
001		1	28x114	400
002		1	28x114	4010
003		2	28x114	4110
004		1	28x57	3916
005		15	28x114	3916
006		15	28x114	400
007		1	28x114	3120
WB-1		1		
IAR2	Foundation - Fundament - Fondation - Fondamenta - Fundering - Immutatud alusraam 	1	45x45	3905
IAR1	Foundation - Fundament - Fondation - Fondamenta - Fundering - Immutatud alusraam 	1	45x45	290
A-PR1	Roof beam - Dachbalken - Panne de toit - Perlina del tetto - Gordingen / dakbalk - Pärilin 	3	44x140	4150
	Roof boards - Dachbretter - Voliges - Perlina per tetto - Dakhout - Katuselaud 	44	90x15	3400
	Roofing felt fillet - Dachpappenleiste - Baguette de fixation du feutre bitumeux - Asse per fissaggio guaina bituminosa - Afdeklijst asfaltpapier - Katusepapiiliist 	1	15x45	3950
HP	H-profile - H-profilis - Profile H - Profilo ad H - H-profiel - H-profiil 	1	58x90	1805
P	Post - Pfosten - Poteau - Piede registrabile - Stijl - Post 	1	70x70	1662
DRV-1	Roof edge reinforcement - Dachrandverstärkung - Corniere de renfort de bord de toit - Rinforzo x tetto - Dakrand versterking - Räästatugevdus 	1	15x45	3950
DRV-1	Roof edge reinforcement - Dachrandverstärkung - Corniere de renfort de bord de toit - Rinforzo x tetto - Dakrand versterking - Räästatugevdus 	1	28x34	3950
KFS-1	Storm protection - Sturmleiste - Latte anti-tempete - Protezione anti vento - Stormverankering / beveiliging - Tormikinnitusliist 	1	22x45	2050
	U-profile - U-profilis - Profile u - Profilo ad u - U-profiel - U-profiil 	1	28x58	1680
GL	Gable moulding - Giebelleiste - Planche de rive - Finitura per frontale e retro del tetto - Gevellijst - Viilulaud 	1	15x120	3950
HS7	Screw for metal corner - Holzschraube für metallwinkel - Vis de fixation des cornieres en métal - Viti per fissare suadretta di metallo di giunzione - Schroef voor metalen hoek - Kruvi nurgikule 	36	3.5x20	
HS9	Screw for u-profile - Schraube zur befestigung u-profilis - Vis a tete fraisée pour profil u - Vite per profilo ad u - Schroef ter bevestiging u-profiel - Kruvi U-profiilile 	1	3.5x50	
HS4	Screw for roof edge reinforcement - Schrauben für dachrandverstärkung - Vis pour fixation corniere renfort de bord de toit - Viti x rinforzo bordo tetto - Schroef voor dakrand versterking - Kruvi räästatugevdusele 	9	3x30	

