

Art. Nr. 993300

1/8

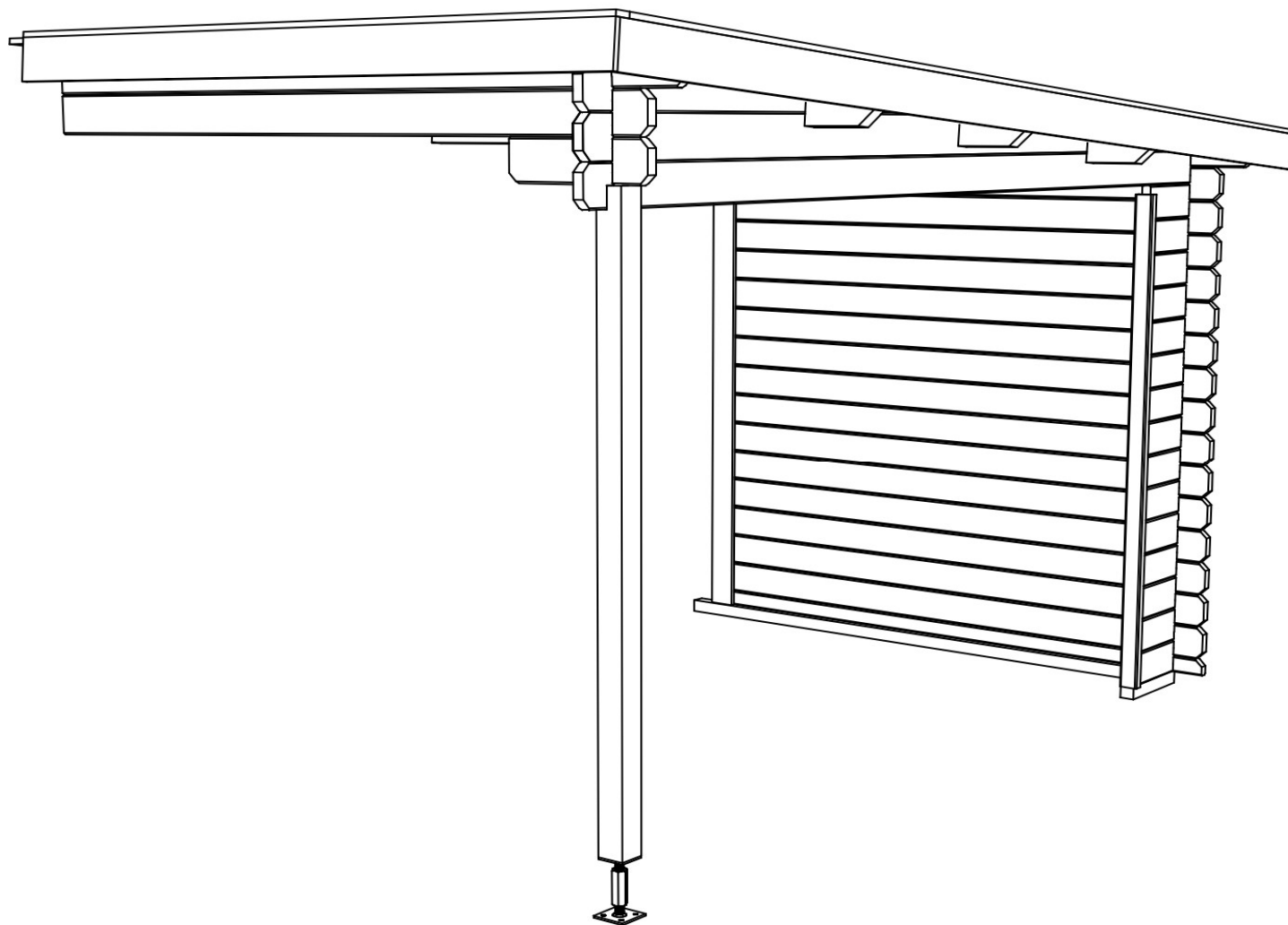

23.10.2024

Art. Nr. 993300

Groundplan - Grundplan - Plan de masse - Planimetria -
Plattegrond - Planimetría - Põhiplaan

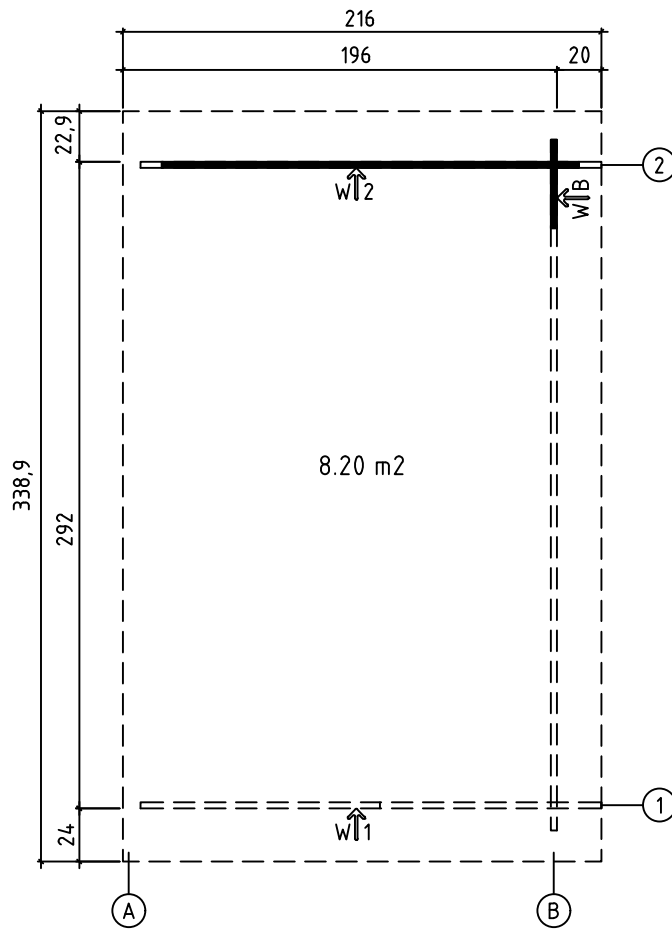

Foundation - Fundament - Fondation - Fondamenta -
Fundering - Bastidor - Immutatud alusraam

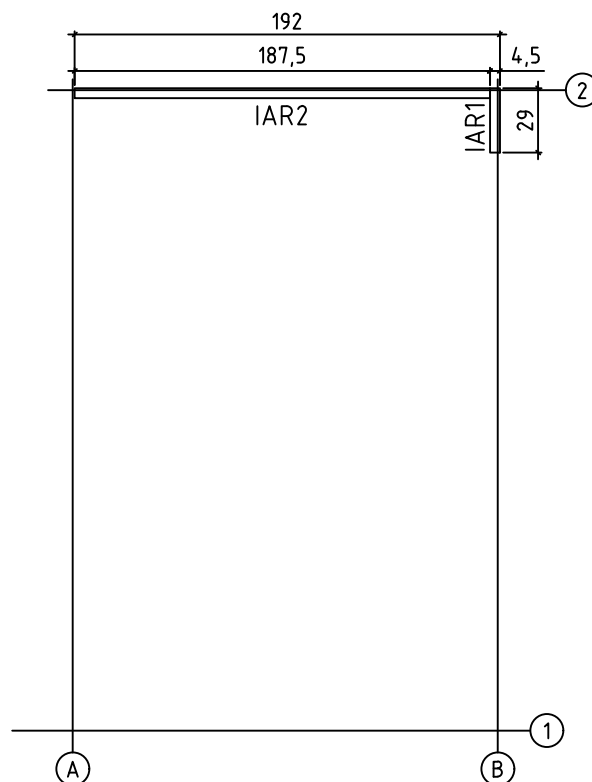

Art. Nr. 993300

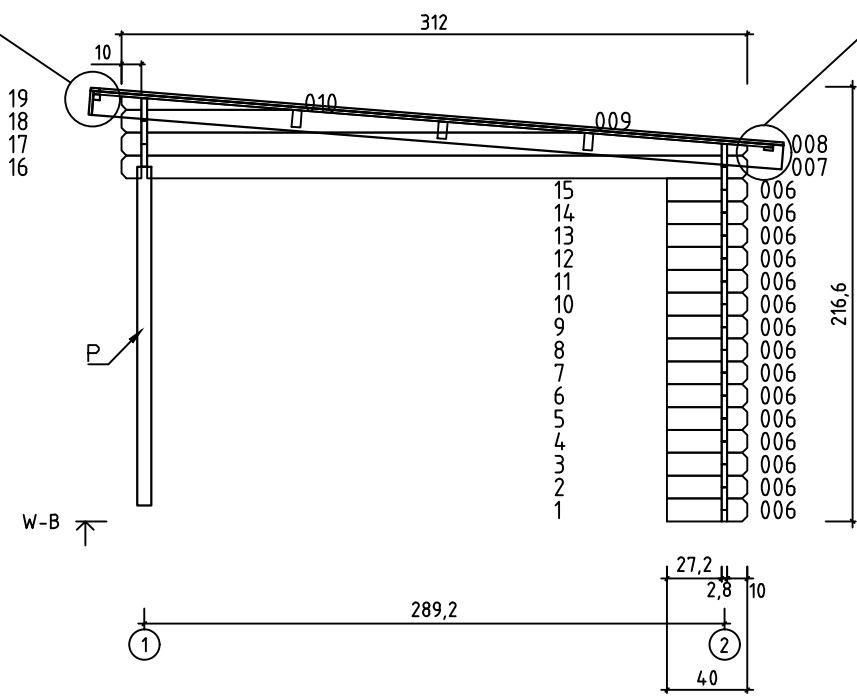
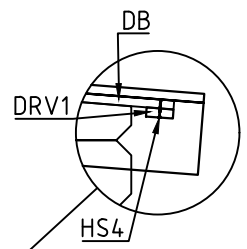
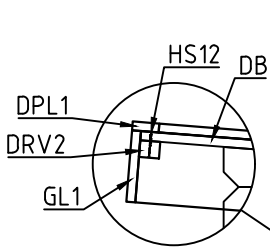
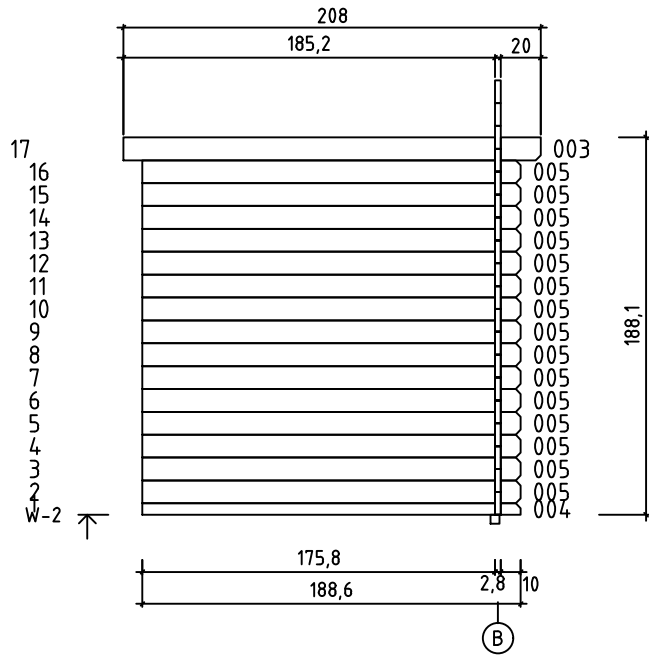
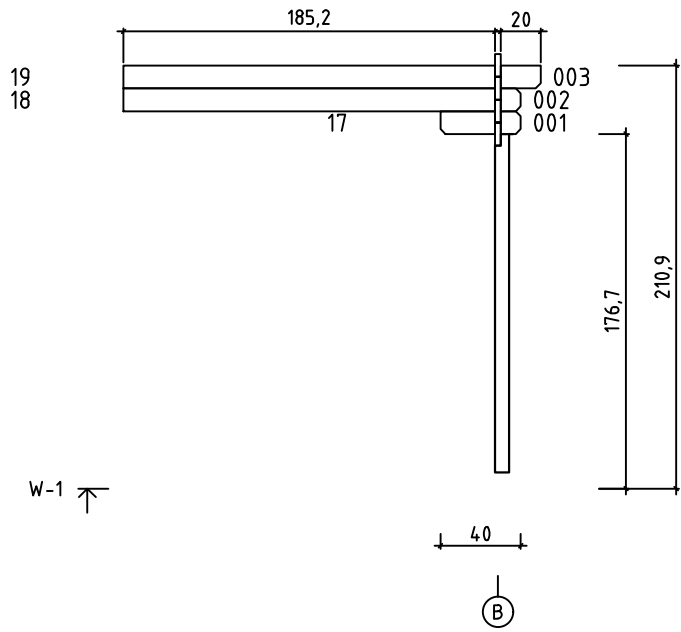

Art. Nr. 993300

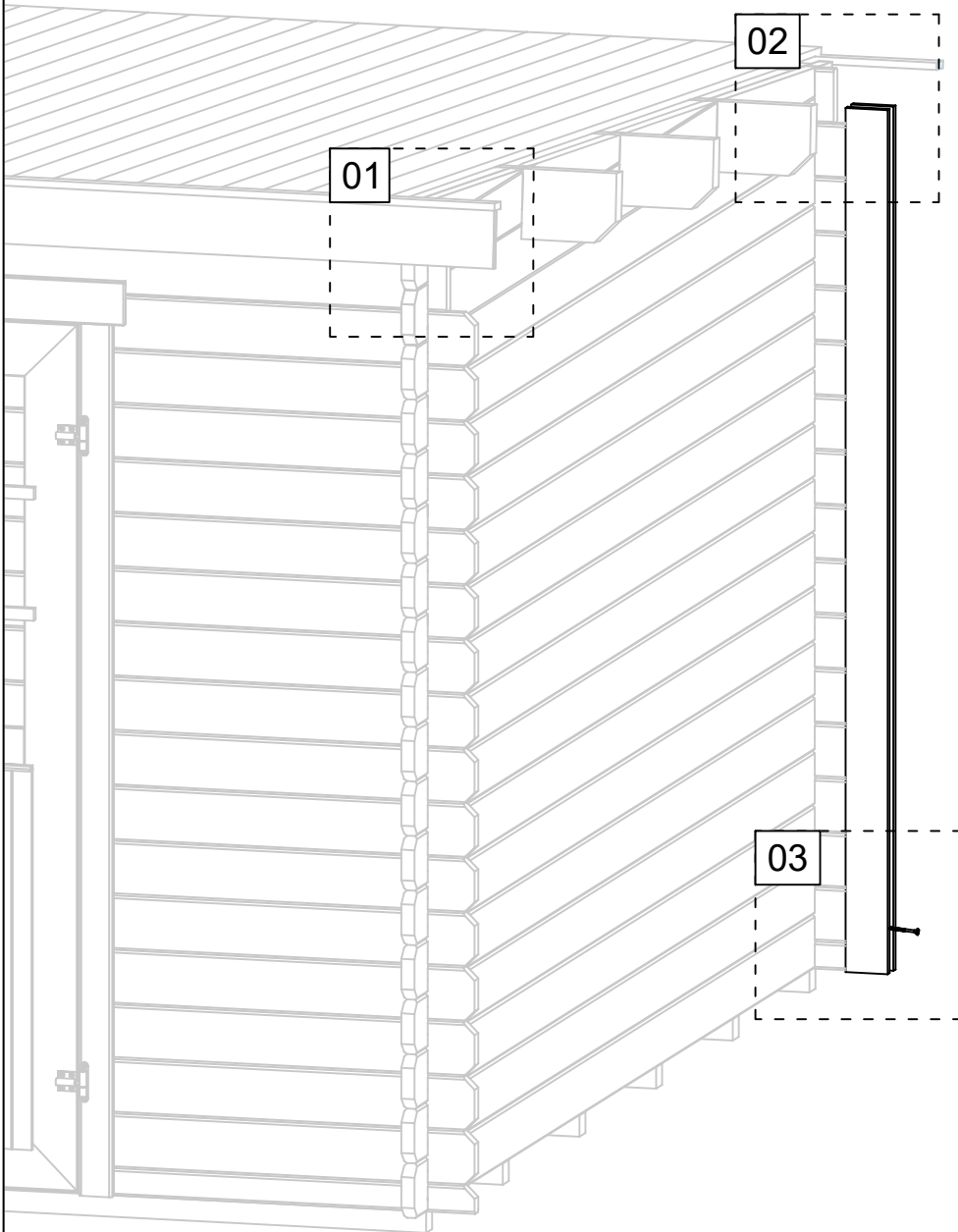

01

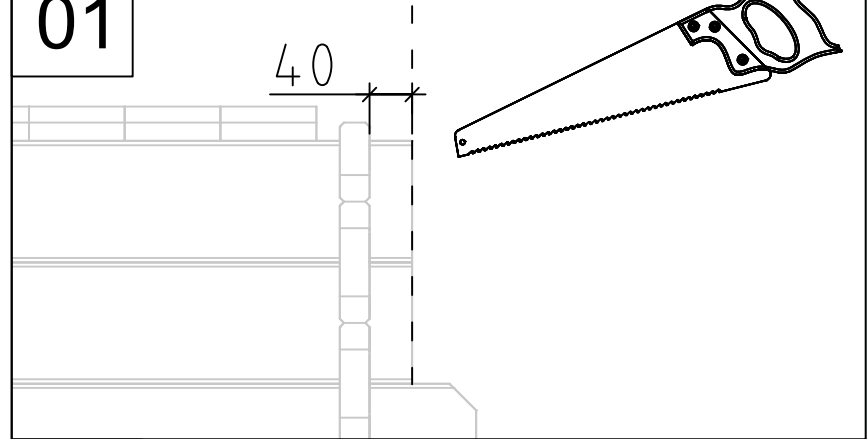

02

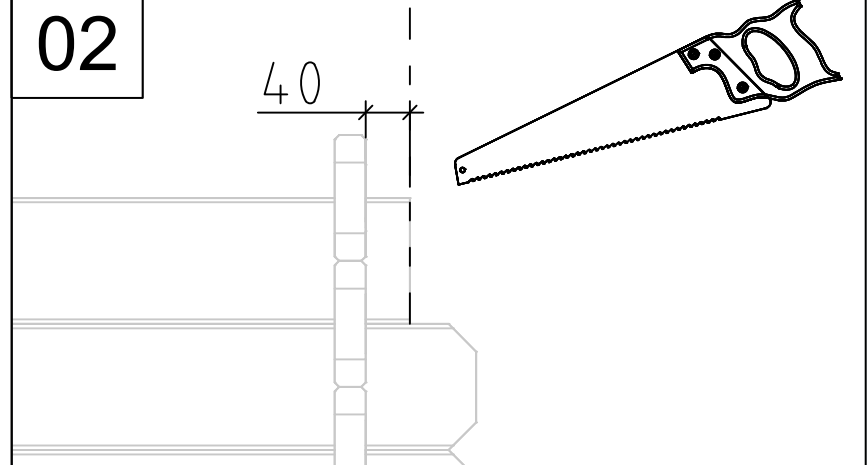

03

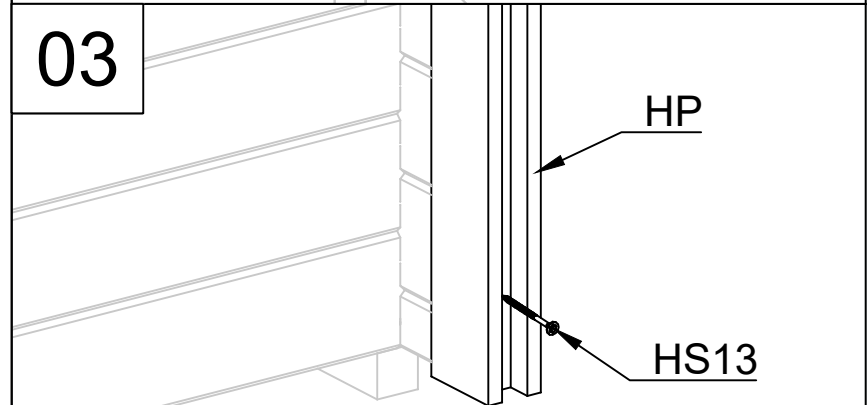

Art. Nr. 993300

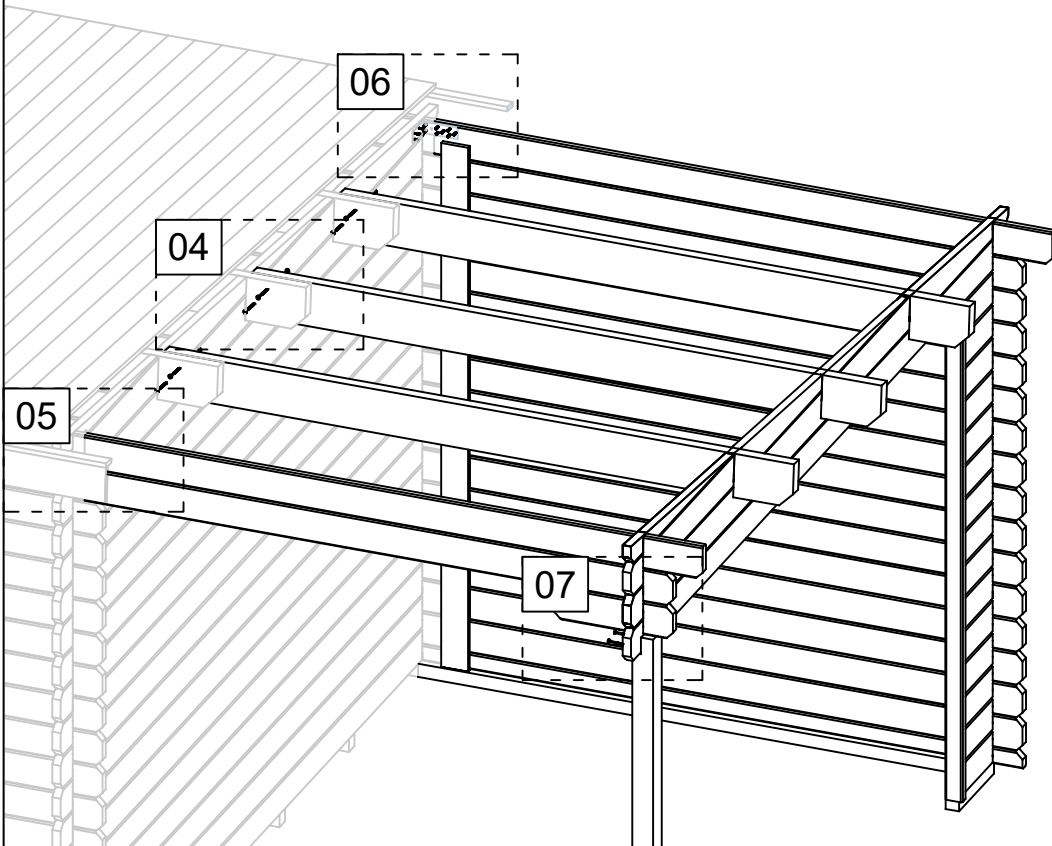

04

HS21

HS21

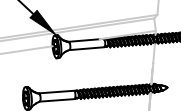

APR-1

05

HS7

MW

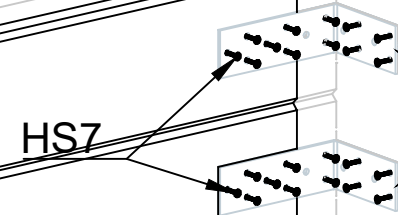

07

HS14

P

23.10.2024

06

HS7

MW



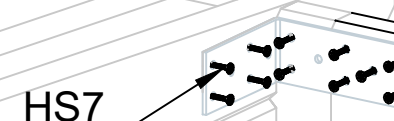





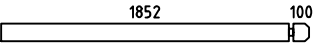
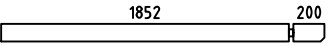
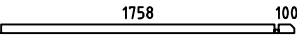
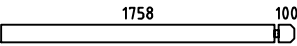

002

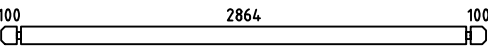
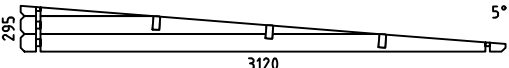
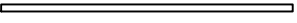

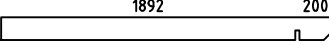
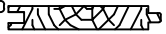
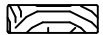
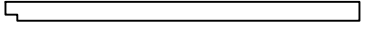
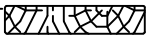
5/8

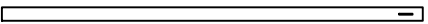
Art. Nr. 993300

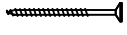

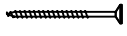
Pos	Piece list - Stückliste - Liste des pièces - Elementi - Stuklijst - Elementos - Tükítabel 23.10.2024 Art. Nr. 993300 7/8	Q	P (mm)	L (mm)
001 34435		1	28x114	400
002 35236		1	28x114	1980
003 40188		2	28x114	2080
004 35237		1	28x57	1886
005 35238		15	28x114	1886
006 29851		15	28x114	400
007 22697		1	28x114	3120
WB-1 37213		1		
IAR2 35253	Foundation - Fundament - Fondation - Fondamenta - Fundering - Bastidor - Immutatud alusraam 	1	45x45	1875
IAR1 34448	Foundation - Fundament - Fondation - Fondamenta - Fundering - Bastidor - Immutatud alusraam 	1	45x45	290
A-PR1 49614	Roof beam - Dachbalken - Panne de toit - Perlina del tetto - Gordingen / dakbalk - Correa - Pärilin 	3	44x146	2120
DB 23057	Roof boards - Dachbretter - Voliges - Perlina per tetto - Dakhout - Tablero de tejado - Katuselaud 	24	90x15.5	3400
DPL1 35254	Roofing felt fillet - Dachpappenleiste - Baguette de fixation du feutre bitumeux - Asse per fissaggio guaina bituminosa - Afdeklijst asfaltpapier - Moldura de fieltro para tejado - Katusepapiiliist 	1	15x45	1920
p 35256	Post - Pfosten - Poteau - Piede registrabile - Stijl - Poste - Post 	1	70x70	1662
GL1 40191	Fascia board - Traufbrett - Bandeau de toit - Finitura lati tetto - Gevellijst - Tablero de alero - Räästalaud 	1	15x120	1920
DRV1 35254	Roof edge reinforcement - Dachrandverstärkung - Corniere de renfort de bord de toit - Rinforzo x tetto - Dakrand versterking - Refuerzo de aleros - Räästatugevdus 	1	15x45	1920
DRV2 40192	Roof edge reinforcement - Dachrandverstärkung - Corniere de renfort de bord de toit - Rinforzo x tetto - Dakrand versterking - Refuerzo de aleros - Räästatugevdus 	1	28x34	1920
KFS-1 2249	Storm protection - Sturmleiste - Latte anti-tempete - Protezione anti vento - Stormverankerung / beveiliging - Moldura antitormenta - Tormikinnitusliist 	1	22x45	2050
UP 34450	U-profile - U-profils - Profile u - Profilo ad u - U-profiel - Perfil en U - U-profiil 	1	28x58	1680
HP 34450	H-profile - H-profils - Profile H - Profilo ad H - H-profiel - Perfil en H - H-profiil 	1	58x90	1805
HS7 5104	Screw for metal corner - Holzschraube für metallwinkel - Vis de fixation des cornieres en métal - Viti per fissare suadretta di metallo di giunzione - Schroef voor metalen hoek - Tornillo para escuadra - Kruvi nurgikule 	36	3.5x20	
HS9 5106	Screw for u-profile - Schraube zur befestigung u-profils - Vis a tete fraisée pour profil u - Vite per profilo ad u - Schroef ter bevestiging u-profiel - Tornillo para perfil en U - Kruvi U-profiilile 	3	3.5x50	
HS4 5102	Screw for roof edge reinforcement - Schrauben für dachrandverstärkung - Vis pour fixation corniere renfort de bord de toit - Viti x rinforzo bordo tetto - Schroef voor dakrand versterking - Tornillo para refuerzo de alero - Kruvi räästatugevdusele 	5	3x30	

