

*JAVA UK*  
*Art.No. 704247*

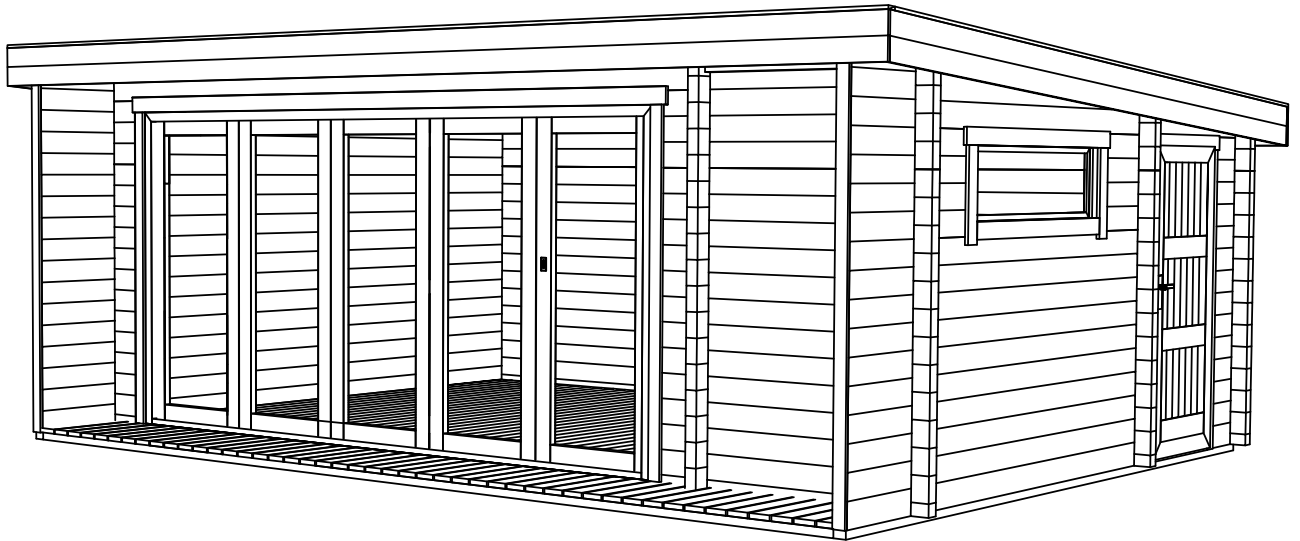

JAVA UK, Art.No.704247  
GRUNDPLAN - GRUNDPLAN - PLAN DE MASSE

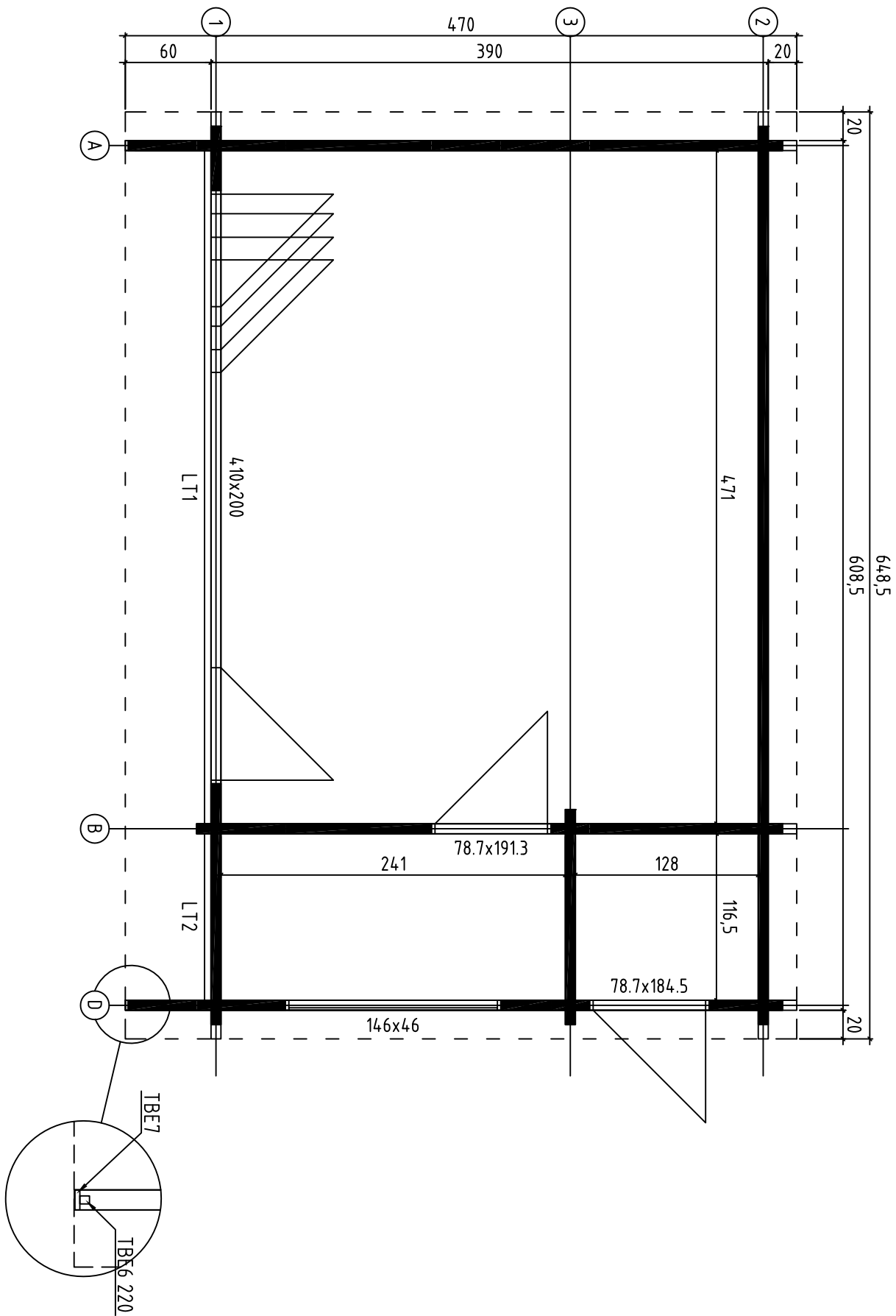

JAVA UK, Art.No.704247  
FOUNDATION - FUNDAMENT - FONDATION

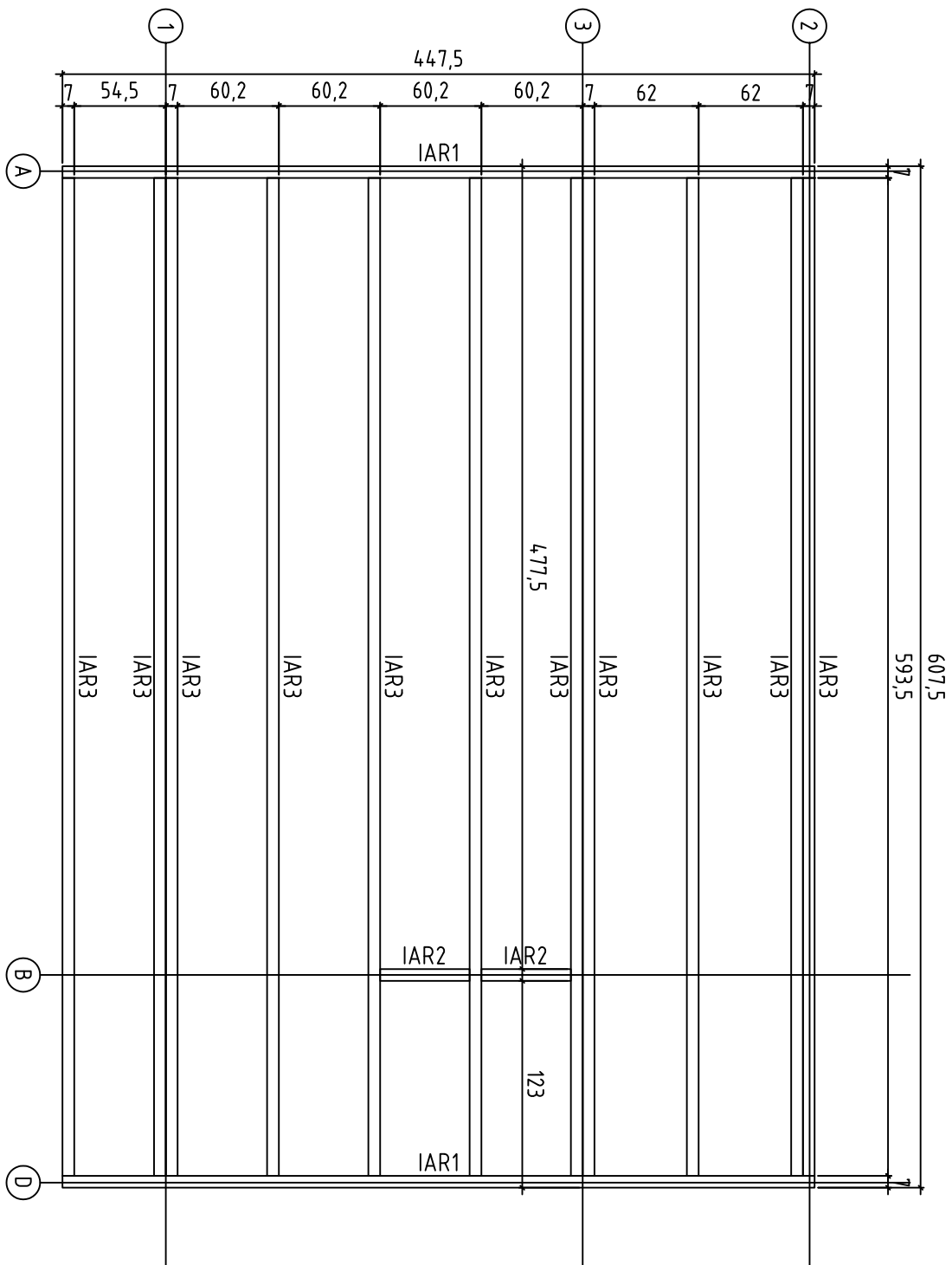

JAVA UK, Art. No. 704247  
FLOOR BOARDS - FUSSBODENBRETTER - PLAN POSE PLANCHER

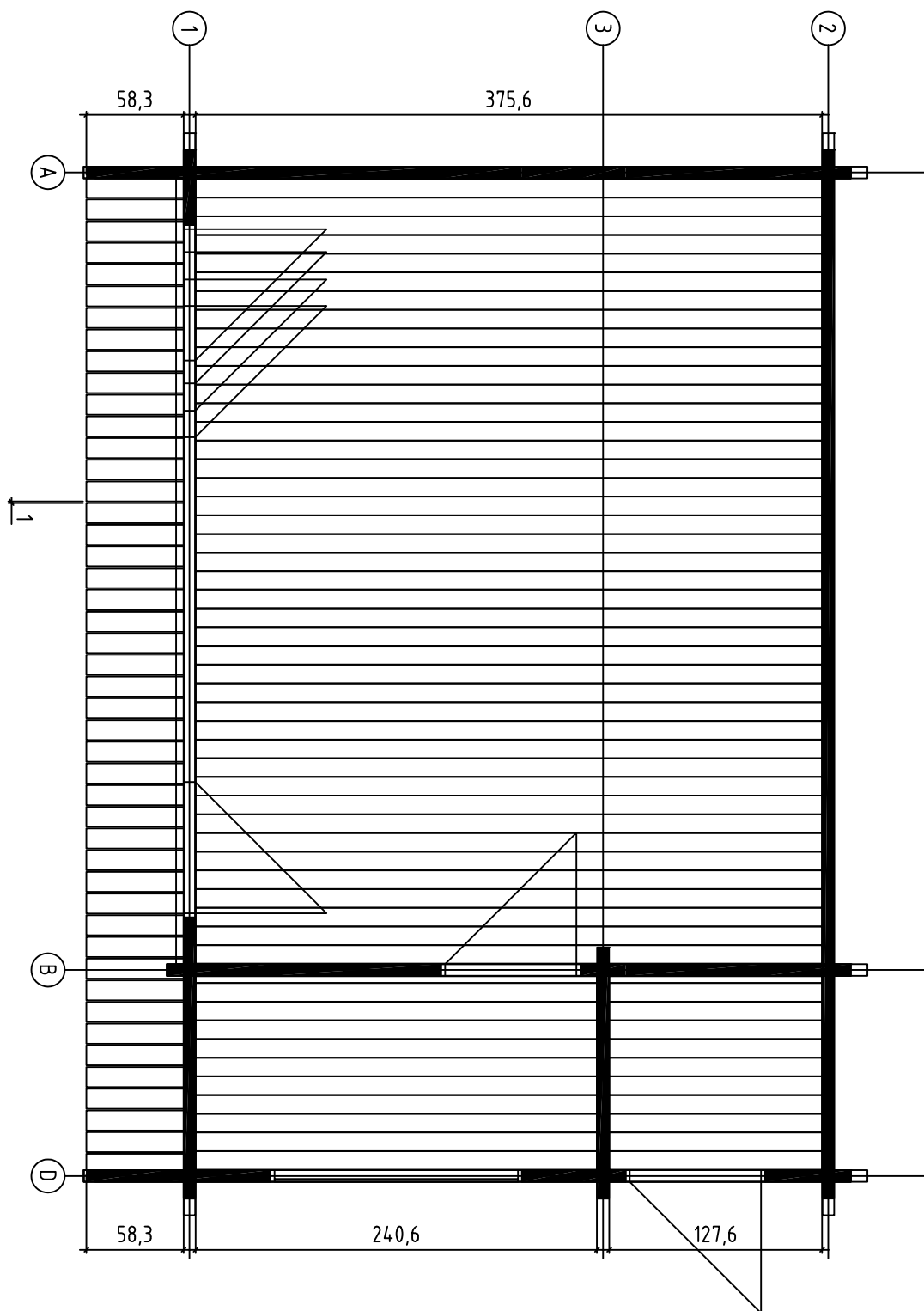

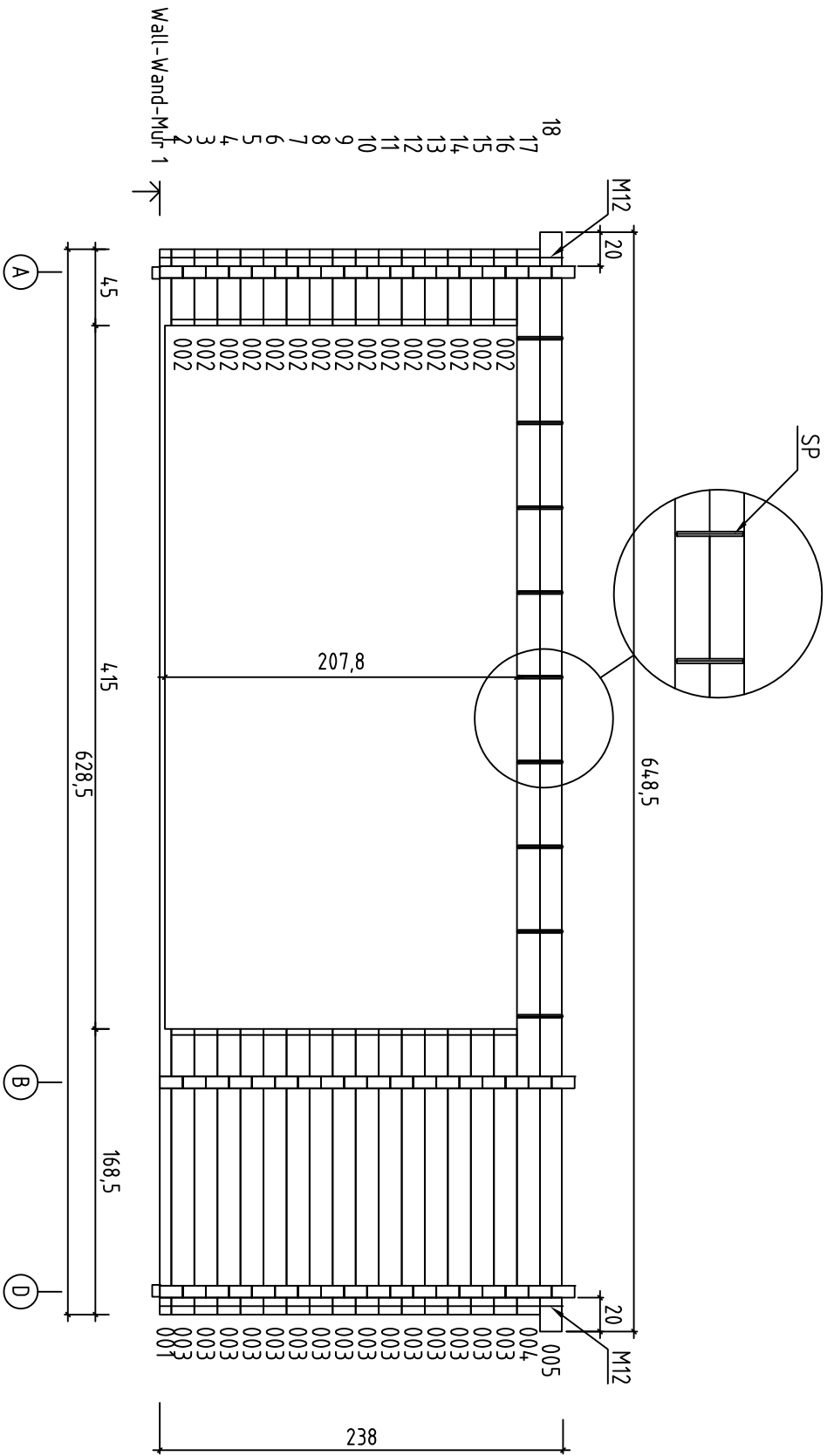

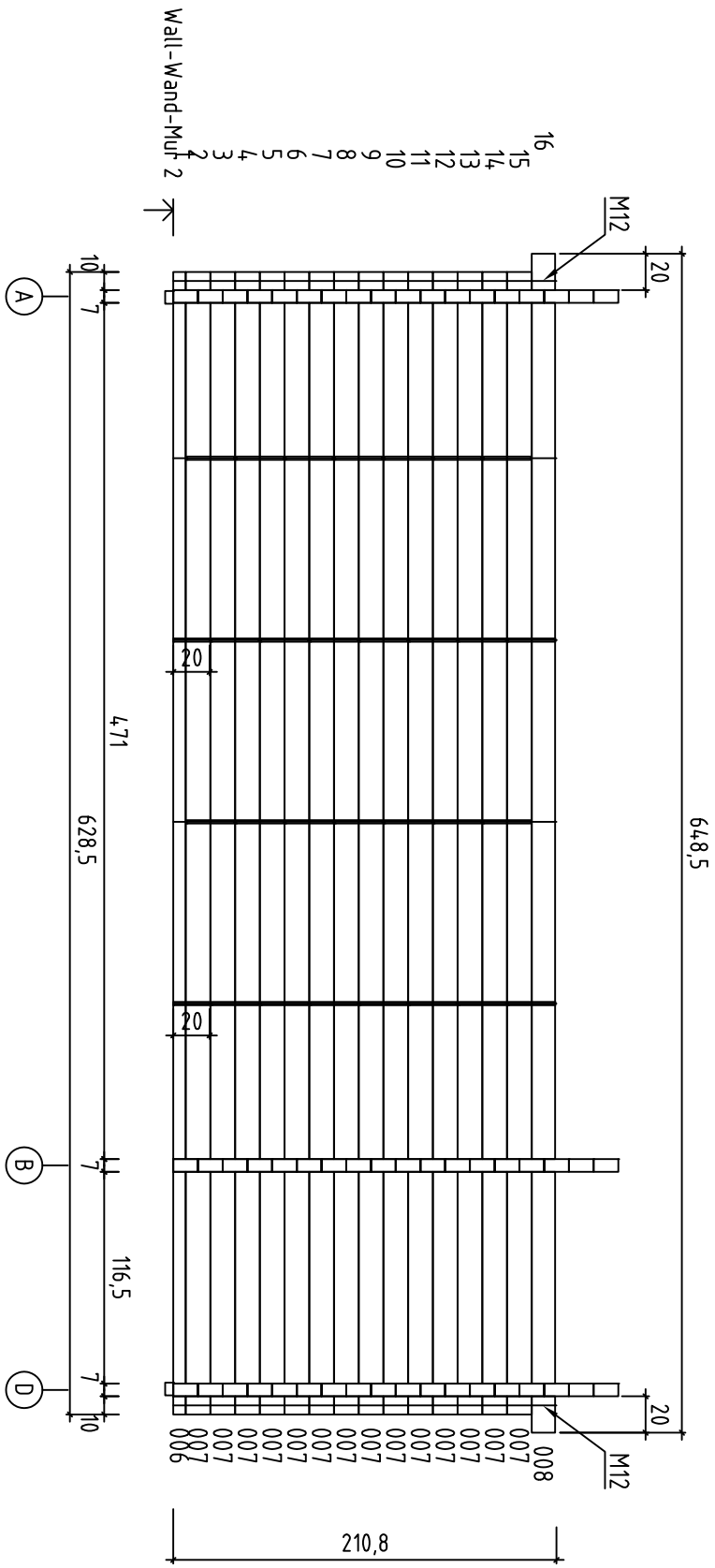

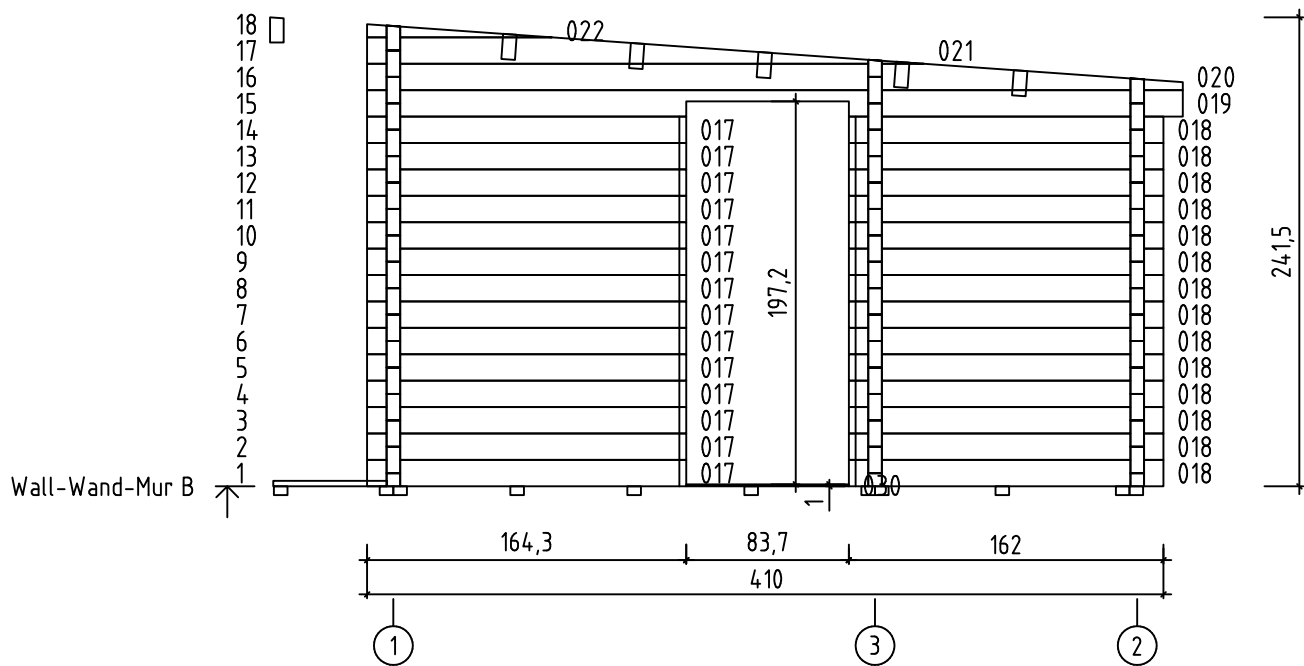
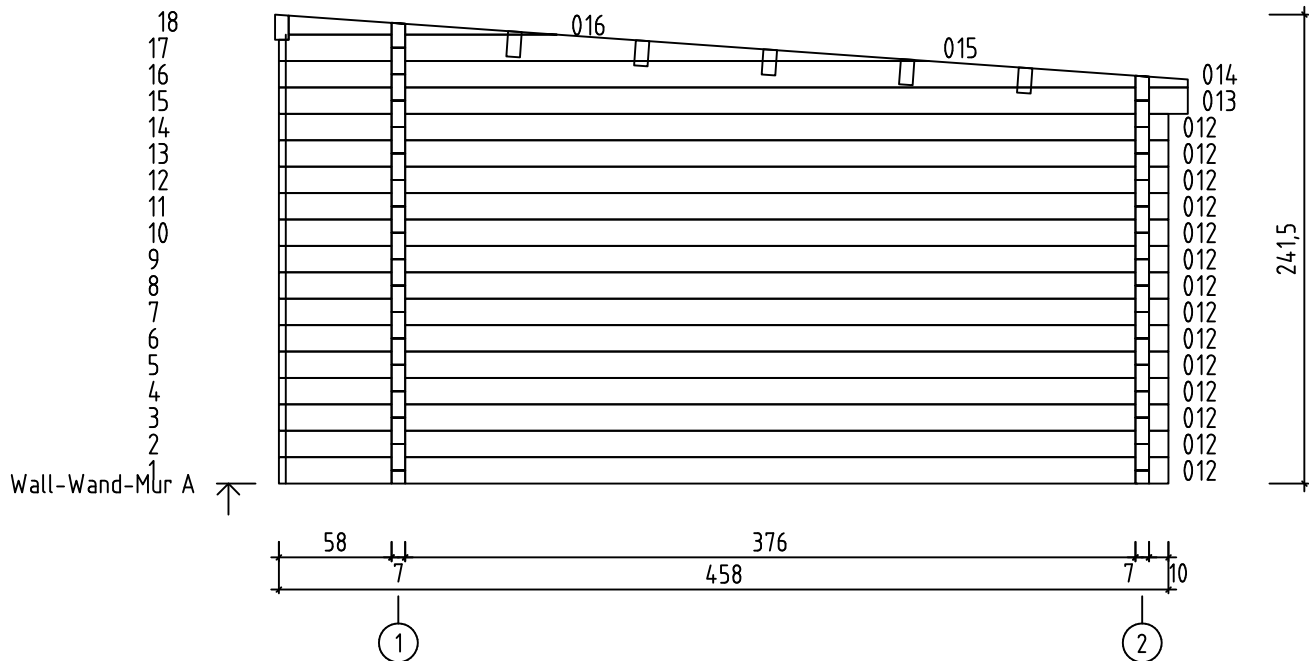

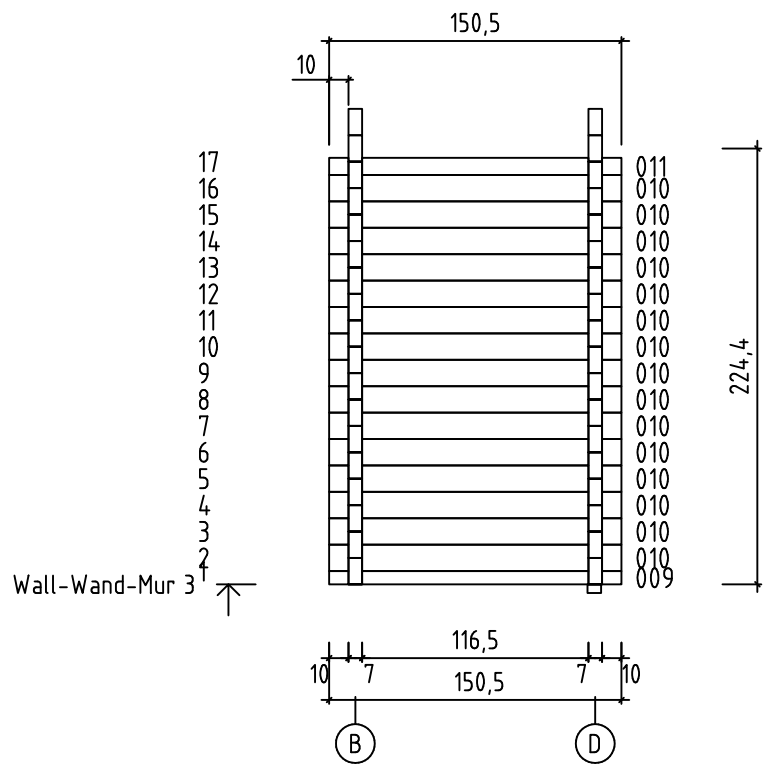
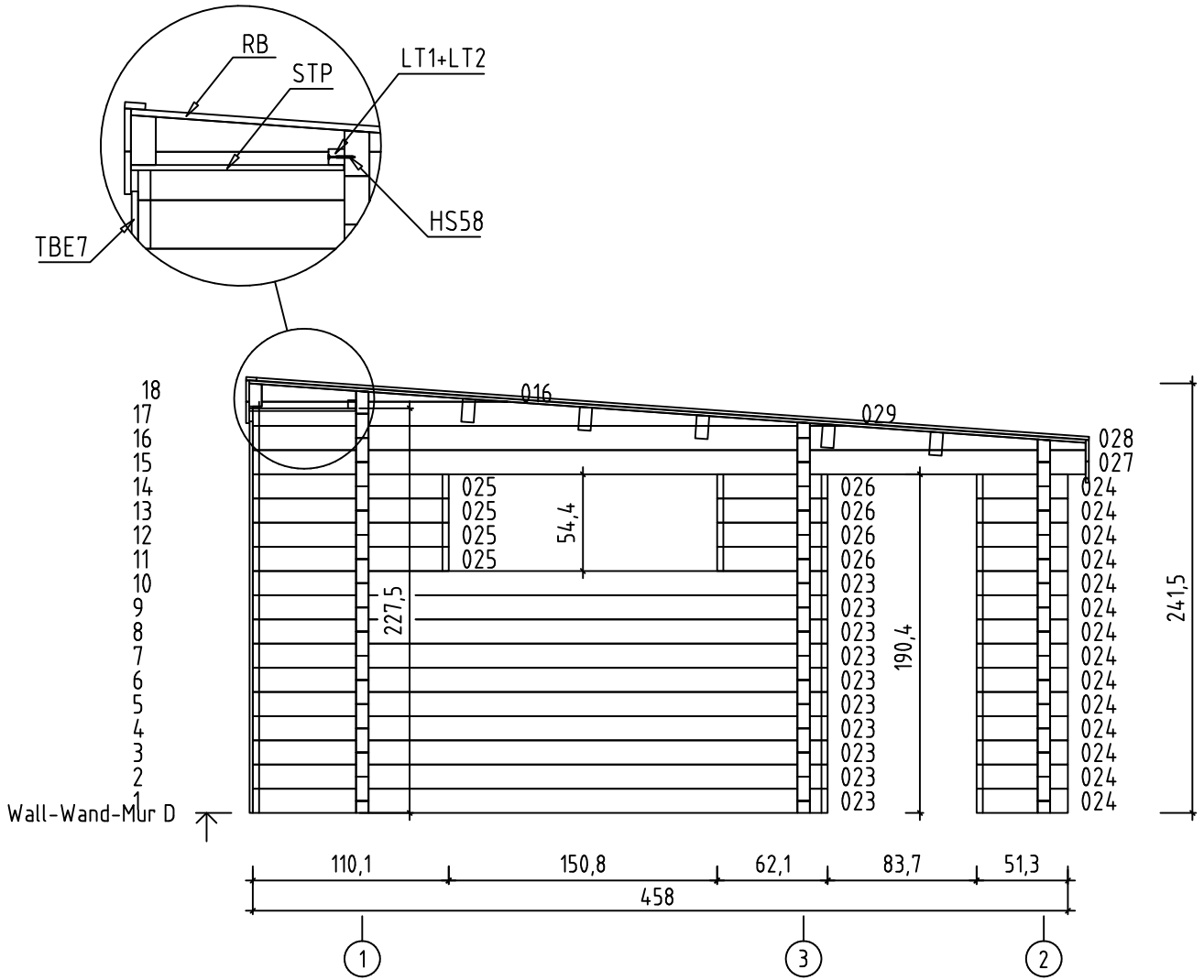



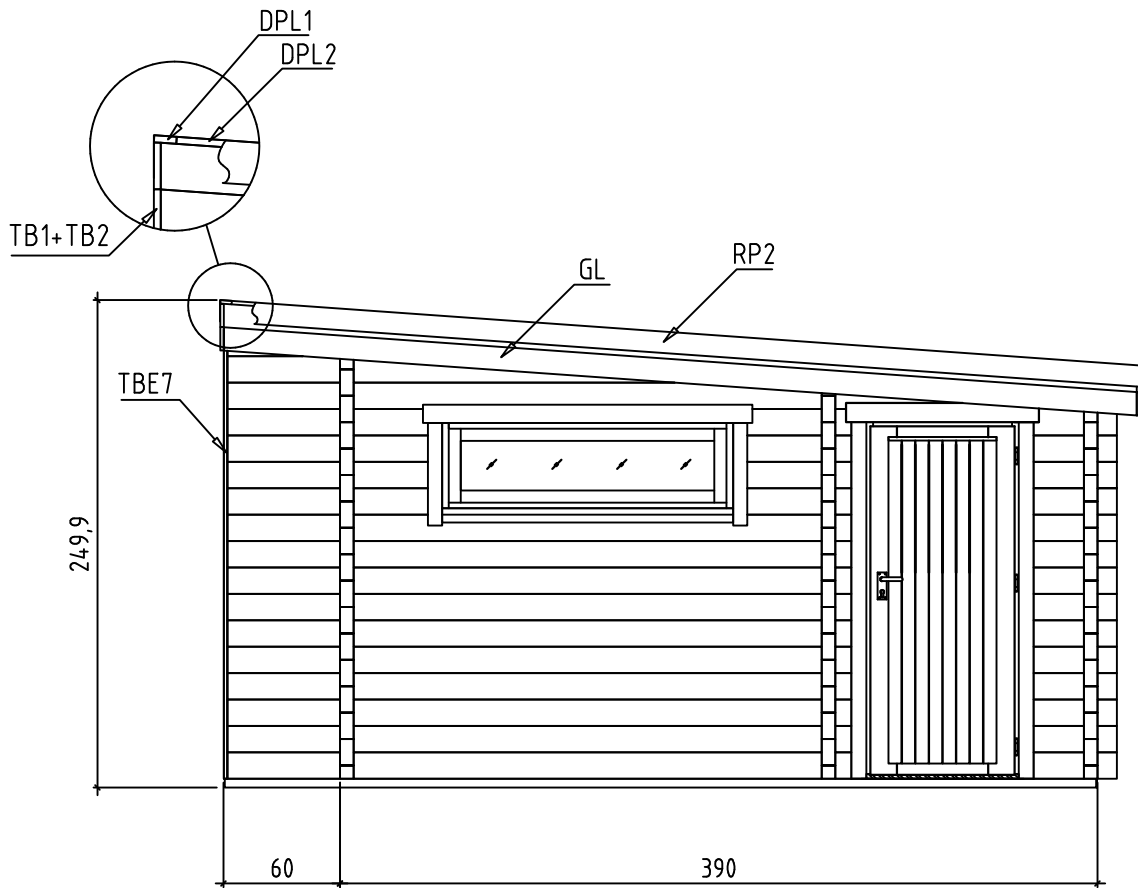
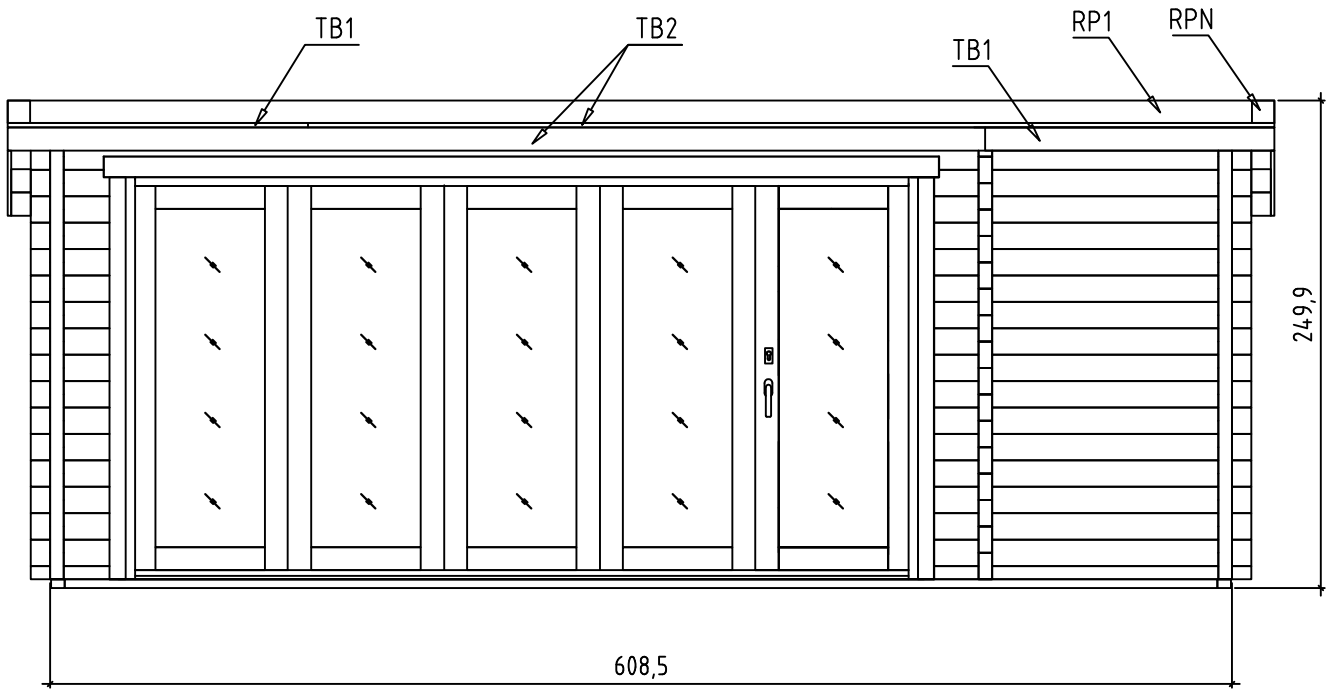



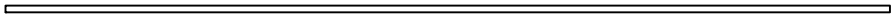
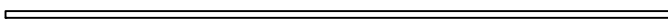

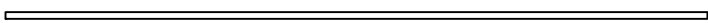

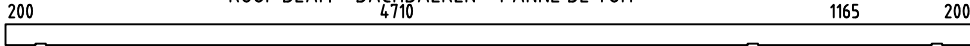
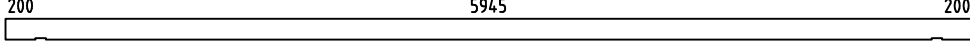





















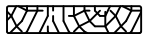
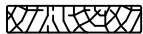







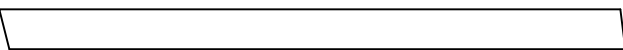





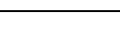

Pos	JAVA UK, Art.No.704247 Piece list - Stückliste - Liste des pieces	Q.	P (mm)	L (mm)
001		1	70x68	6285
002		15	70x136	450
003		15	70x136	1685
004		1	70x136	6285
005		1	70x129	6485
006		1	70x68	6285
007		14	70x136	6285
008		1	70x129	6485
009		1	70x68	1505
010		15	70x136	1505
011		1	70x88	1505
012		14	70x136	4580
017		14	70x136	1643
018		14	70x136	1620
023		10	70x136	3230
024		14	70x136	513
025		4	70x136	1101
026		4	70x136	621
030		1	70x10	837
WA-1		1		
WB-1		1		
WD-1		1		

Pos	JAVA UK, Art.No.704247 Piece list - Stückliste - Liste des pieces	Q.	P (mm)	L (mm)
IAR3	FOUNDATION - FUNDAMENT - FONDATION 	11	70x45	5935
IAR1	FOUNDATION - FUNDAMENT - FONDATION 	2	70x45	4475
IAR2	FOUNDATION - FUNDAMENT - FONDATION 	2	70x45	533
LT1	MEZZANINE FLOOR JOISTS - HALBGESCHOSS BALKEN - SOLIVES DE PLANCHER MEZZANINE 	1	45x45	4710
LT2	MEZZANINE FLOOR JOISTS - HALBGESCHOSS BALKEN - SOLIVES DE PLANCHER MEZZANINE 	1	45x45	1165
A-PR1	ROOF BEAM - DACHBALKEN - PANNE DE TOIT 	5	70x140	6485
A-PR2	ROOF BEAM - DACHBALKEN - PANNE DE TOIT 	1	70x140	6485
STP	CEILING BOARDS - DECKENBRETTER - VOLIGES SOUS PLAFOND 	54	111x15	598
PTL	FLOOR BOARDS - FUSSBODENBRETTER - LAME DE PLANCHER 	43	112x28	3756
PTL	FLOOR BOARDS - FUSSBODENBRETTER - LAME DE PLANCHER 	11	112x28	2406
PTL	FLOOR BOARDS - FUSSBODENBRETTER - LAME DE PLANCHER 	11	112x28	1276
RB	ROOF BOARDS - DACHBRETTER - VOLIGES 	72	90x18	4712
SV2	TERRACE BOARDS - TERRASSENBRETTER - PLANCHER DE TERRASSE 	46	120x28	586
FL	FLOOR FILLET-FUSSBODENLEISTE - CORNIERE DE FINITION DU PLANCHER 		18x18	28.93
DPL1	ROOFING FELT FILLET - DACHPAPPENLEISTE - BAGUETTE DE FIXATION DU FEUTRE BITUMEUX 	2	18x58	3262
DPL2	ROOFING FELT FILLET - DACHPAPPENLEISTE - BAGUETTE DE FIXATION DU FEUTRE BITUMEUX 	2	18x58	4690
M12	TREADED ROD M12 - GEWINDESTANGE M12 - TIGE FILETÉE M12 	2		128
M12	TREADED ROD M12 - GEWINDESTANGE M12 - TIGE FILETÉE M12 	2		400
M12	TREADED ROD M12 - GEWINDESTANGE M12 TIGE FILETÉE M12 	4		2000
LPL	FIXING FILLET - FIXIRUNGSLEISTE - PROFIL DE FIXATION 	2	20x70	500
LPL	FIXING FILLET - FIXIRUNGSLEISTE - PROFIL DE FIXATION 	2	20x70	787
LPL	FIXING FILLET - FIXIRUNGSLEISTE - PROFIL DE FIXATION 	2	20x70	1460
LPL	FIXING FILLET - FIXIRUNGSLEISTE - PROFIL DE FIXATION 	2	20x70	1865
LPL	FIXING FILLET - FIXIRUNGSLEISTE - PROFIL DE FIXATION 	2	20x70	1933
LPL	FIXING FILLET - FIXIRUNGSLEISTE - PROFIL DE FIXATION 	2	20x70	2020

Pos	JAVA UK, Art.No.704247 Piece list - Stückliste - Liste des pieces		Q.	P (mm)	L (mm)
LPL	FIXING FILLET - FIXIRUNGSLEISTE - PROFIL DE FIXATION		1	20x70	4100
TBE7	CORNER FILLET - ECKLEISTE - BAGUETTE DE FIXATION DU ANGLE		2	18x70	2200
TB1	EAVES BOARD - TRAUFBRETT - BANDEAU DE TOIT		4	18x120	1489
TB2	EAVES BOARD - TRAUFBRETT - BANDEAU DE TOIT		4	18x120	5034
DRV	ROOF EDGE REINFORCEMENT - DACHRANDVERSTÄRKUNG - CORNIERE DE RENFORT DE BORD DE TOIT		2	28x34	200
DRV	ROOF EDGE REINFORCEMENT - DACHRANDVERSTÄRKUNG - CORNIERE DE RENFORT DE BORD DE TOIT		1	28x34	1165
DRV	ROOF EDGE REINFORCEMENT - DACHRANDVERSTÄRKUNG - CORNIERE DE RENFORT DE BORD DE TOIT		1	28x34	4710
TBE6	FIXING FILLET FOR WINDOW - FIXIRUNGSLEISTE FÜR FENSTER - PROFIL DE FIXATION DES FENETRES		2	28x34	500
TBE6	FIXING FILLET FOR DOOR - FIXIRUNGSLEISTE FÜR TÜR - PROFIL DE FIXATION DES PORTES		2	28x34	1825
TBE6	FIXING FILLET FOR DOOR - FIXIRUNGSLEISTE FÜR TÜR - PROFIL DE FIXATION DES PORTES		2	28x34	1865
TBE6	FIXING FILLET FOR DOOR - FIXIRUNGSLEISTE FÜR TÜR - PROFIL DE FIXATION DES PORTES		2	28x34	1970
TBE6	FIXING FILLET FOR DOOR - FIXIRUNGSLEISTE FÜR TÜR - PROFIL DE FIXATION DES PORTES		2	28x34	2200
GL	GABLE MOULDING - GIBELLEISTE PLANCHE DE RIVE 		4	18x120	4720
RP1	METAL PLATE FOR EAVES BOARDS - TRAUFBLECHE				6,52 m.
RP2	METAL PLATE FOR EAVES BOARDS - TRAUFBLECHE				9,5 m.
RPN	METAL CORNER FOR EAVES BOARDS - TRAUFBLECHE		2		
KL4	LENGTHENING BOLT FOR TREADED ROD - VERLÄNGERUNGSMUTTER FÜR GEWINDESTANGE - MANCHON DE RACCORDEMENT DE TIGE FILETÉE		4		
KL1	DRIVE NUT TREADED ROD - EINSHLAGMUTTER FÜR GEWINDESTANGE - ÉCROU A FRAPPER POUR TIGE FILITÉE		4		
KL2	NUT FOR TREADED ROD - MUTTER FÜR GEWINDESTANGE - ÉCROU POUR TIGE FILETÉE		4		
KL3	PLAIN WASHER TREADED ROD - UNTERLEGSCHIEBE FÜR GEWINDESTANGE - RONDELLE PLATE POUR TIGE FILETÉE		4		
HS83	SCREW FOR FIXING FILLET - SCHRAUBEN FÜR FIXIRUNGSLEISTE - VIS POUR PROFIL DE FIXATION		76	3.5x50	
HS82	SCREW FOR CORNER FILLET - SCHRAUBEN FÜR ECKLEISTE - VIS POUR BAGUETTE DE FIXATION DU ANGLE		10	3.5x50	
HS32	SCREW FOR EAVES BOARDS - SCHRAUBEN FÜR TRAUFBRETT - VIS DE FIXATION POUR BANDEAU DE TOIT		42	3.5x50	
HS84	SCREW FOR FIXING FILLET - SCHRAUBEN FÜR FIXIRUNGSLEISTE - VIS POUR PROFIL DE FIXATION		42	3.5x50	
HS16	SCREW FOR GABLE MOULDING - SCHRAUBEN FÜR GIBELLEISTE - VIS DE FIXATION POUR PLANCHE DE RIVE		58	3.5x50	

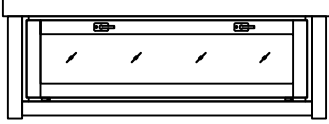
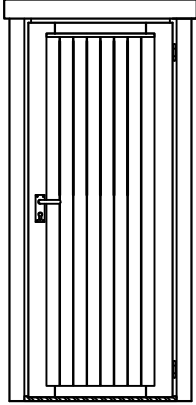
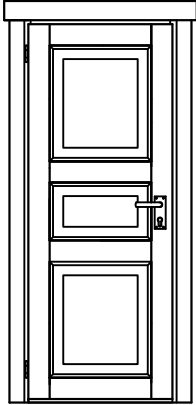
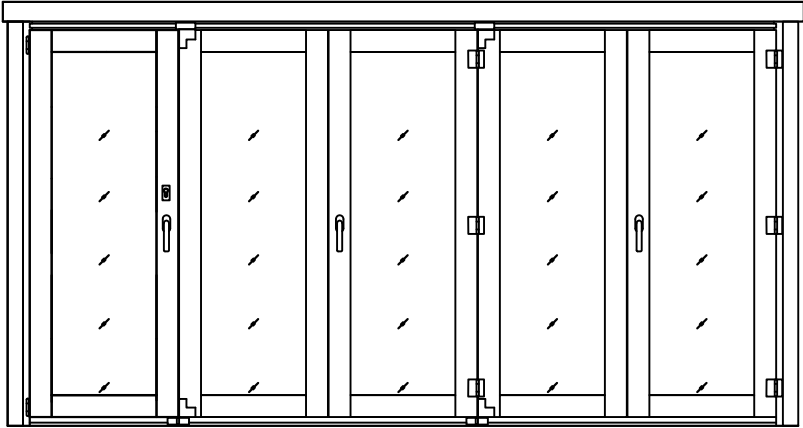

Pos	JAVA UK, Art.No.704247 Piece list - Stückliste - Liste des pieces	Q.	P (mm)	L (mm)
Premi m A.0U	WINDOW-FENSTER-FENETRE 1500x500  	1		
Premi um U. 2LP.c	DOOR-TÜR-PORTE 827x1865  	1		
U.3TV	DOOR-TÜR-PORTE 827x1933  	1		
	DOOR - TÜR - PORTE 4140x2020  	1		

