

Art.nr. 344399

1/5

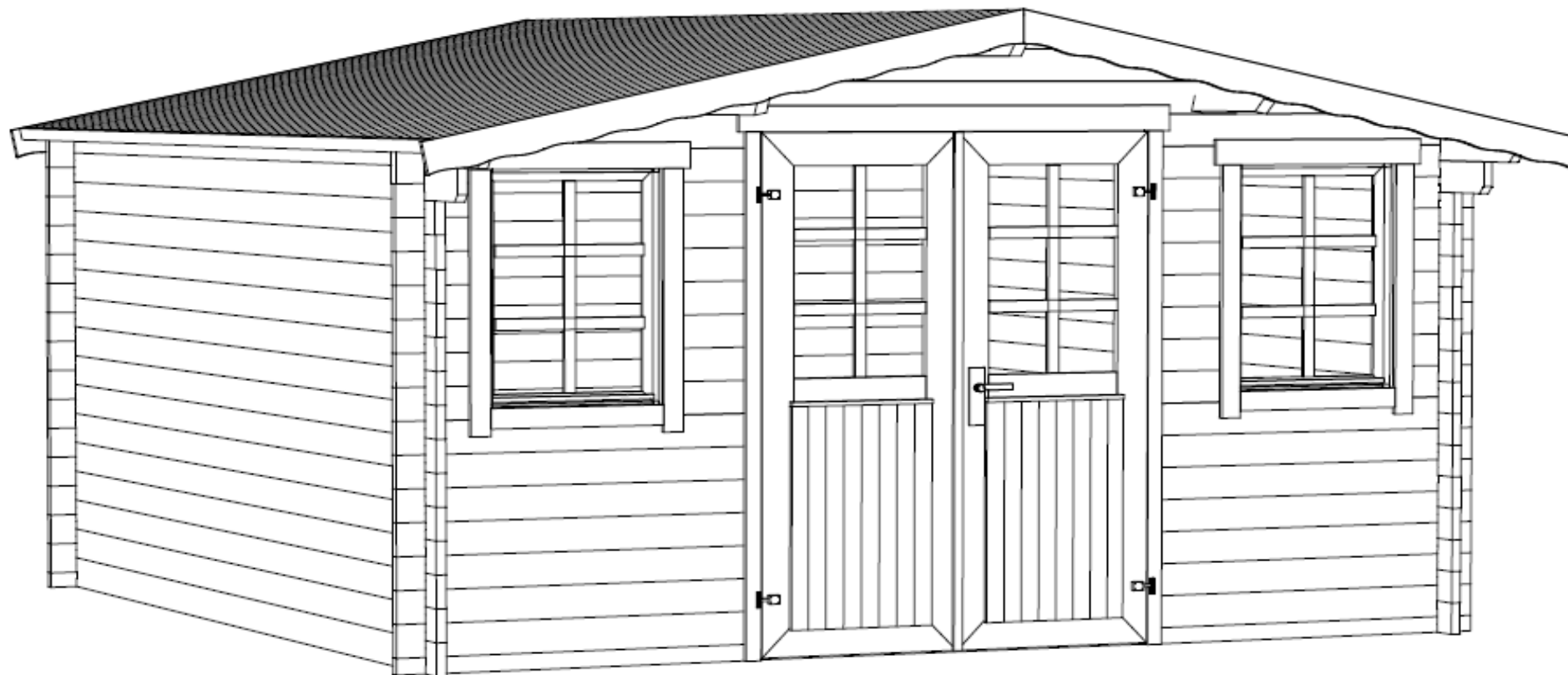

Art.Nr. 344399



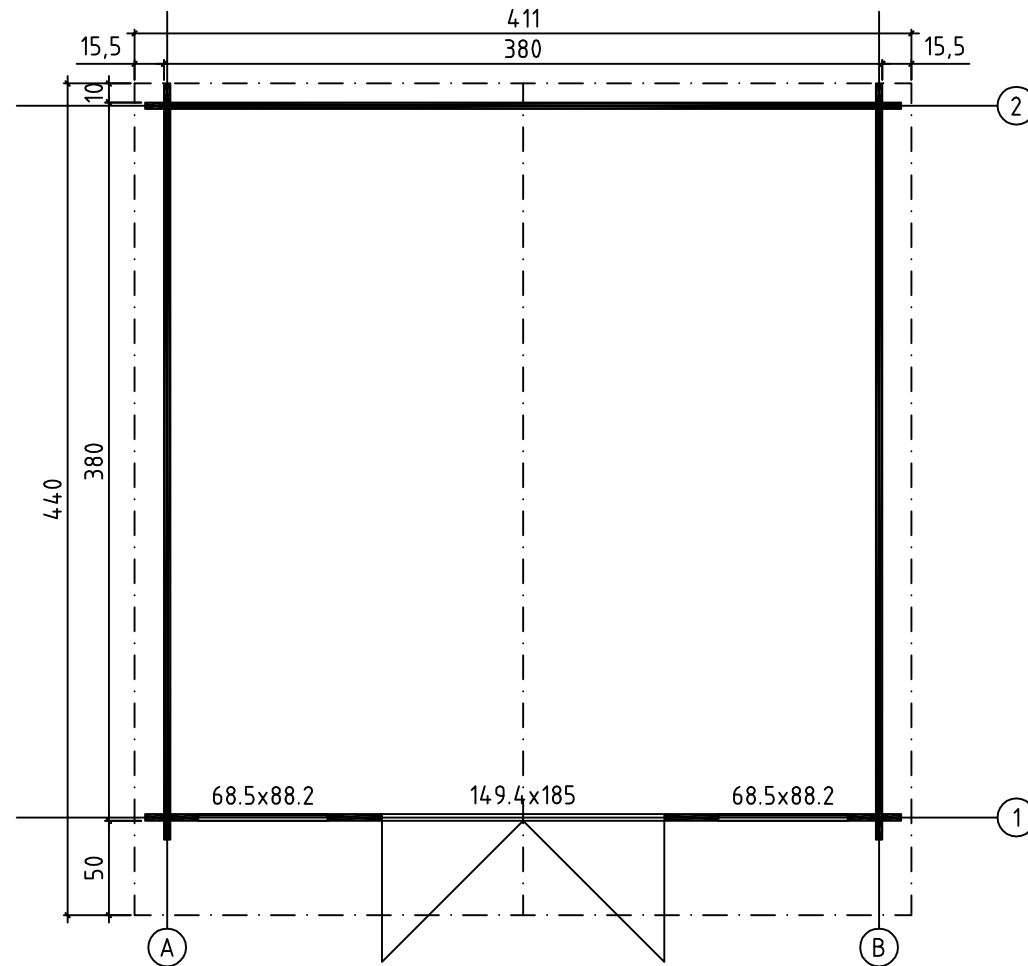

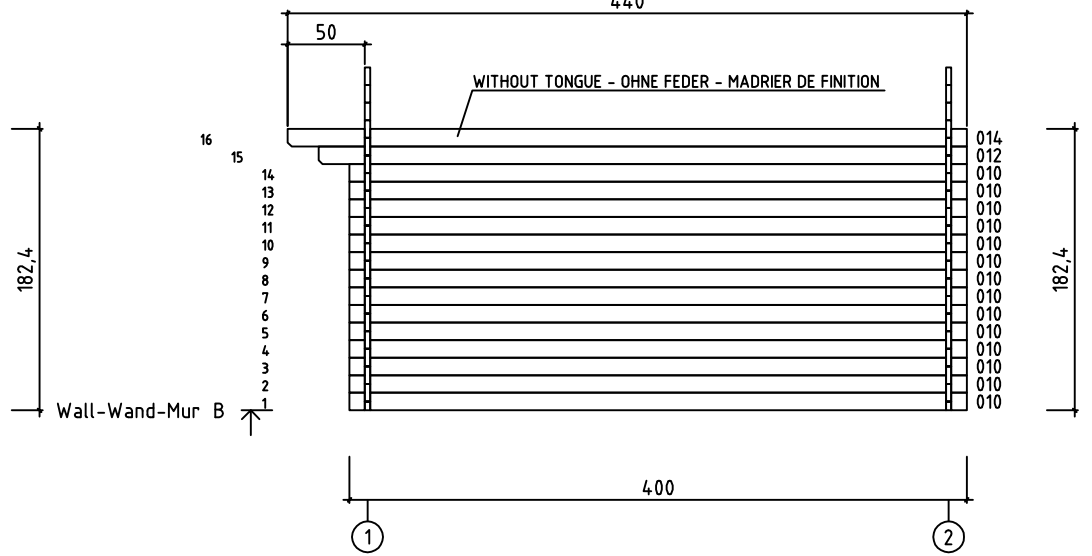
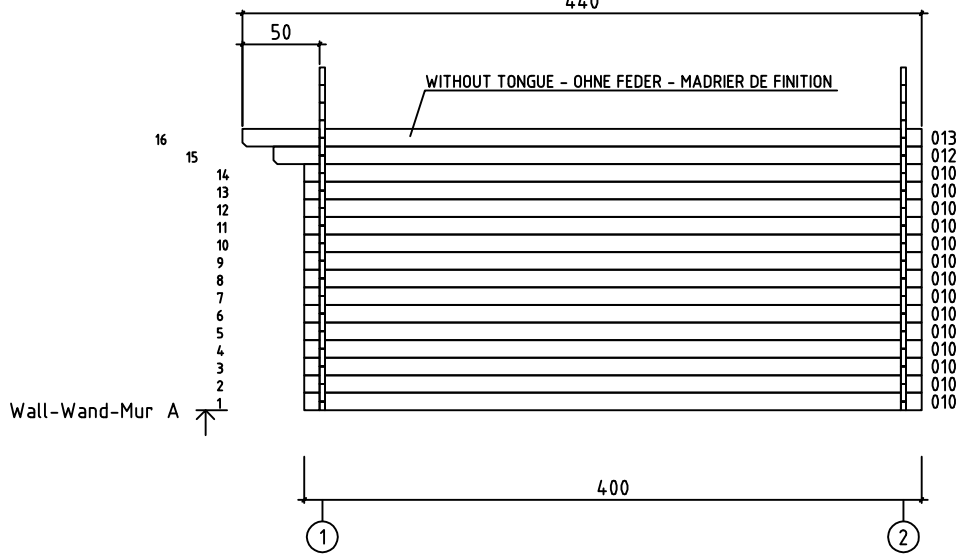
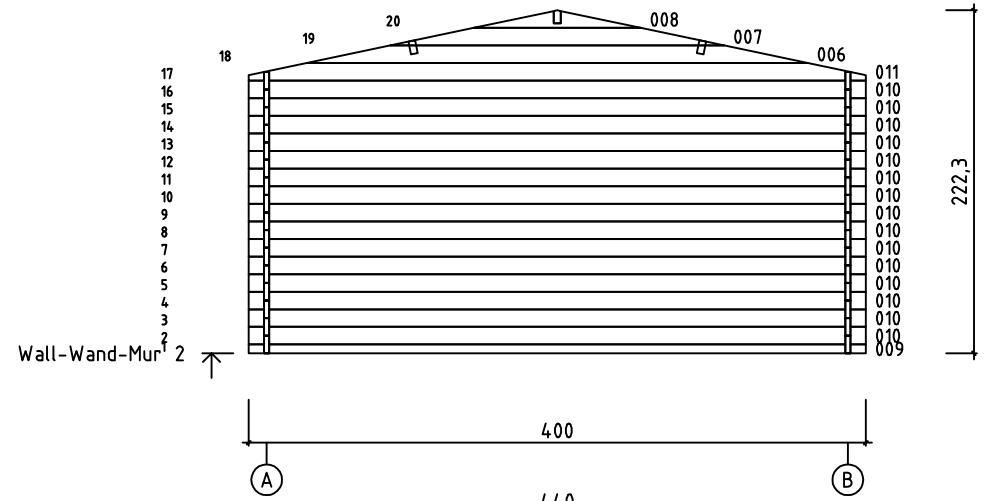
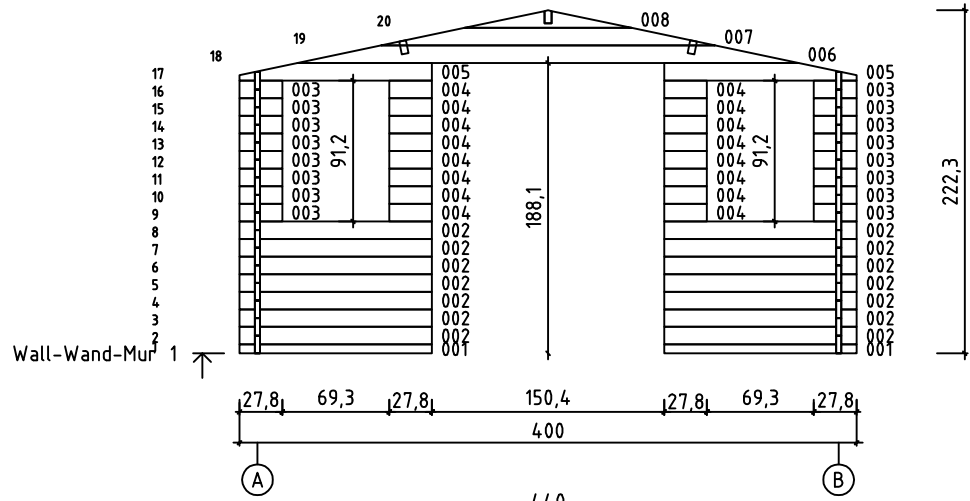

GROUNDPLAN - GRUNDPLAN - PLAN DE MASSE



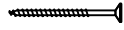

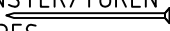
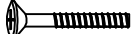
Art.Nr. 344399

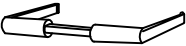
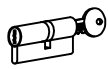

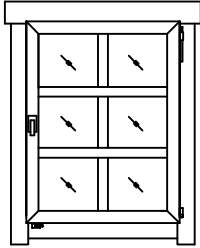
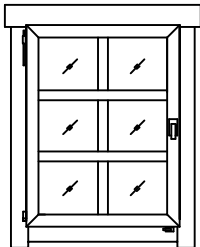
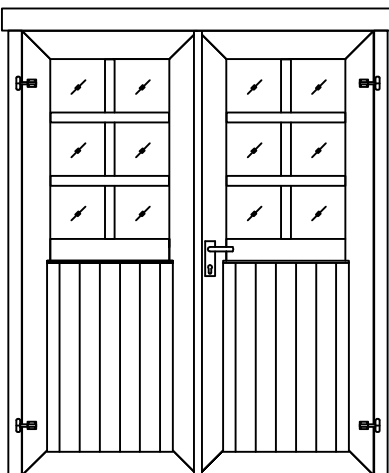
Pos	18.10.2013	Piecelist - Stücklist - Liste des composants Art.Nr. 344399	4/5	Q.	P. (mm)	L. (mm)
001				2	34x57	1248
002				14	34x114	1248
003				16	34x114	278
004				16	34x114	278
009				1	34x57	4000
010				43	34x114	4000
012				2	34x114	4200
013				1	34x120	4400
014				1	34x120	4400
W1-1				1		
W2-1				1		
PR1		ROOF BEAM - DACHBALKEN - PANNE DE TOIT		1	44x140	4400
APR1		ROOF BEAM - DACHBALKEN - PANNE DE TOIT		2	44x140	4400
		ROOF BOARDS - DACHBRETTER - VOLIGES		98	90x15	2100
		GABLE MOULDING - GIEBELLEISTE - - PLANCHE DE RIVE		4	15x120	2150
		EAVES BOARD - TRAUFBRETT - BANDEAU DE TOIT		4	15x45	2200
		WINDOW HANDLE FITTINGS-FENSTERGRIFF - POIGNÉE D'OUVERTURE DE FENETRE		2		
HS22		SCREW FOR FIXING DOOR TO THE WALL - SCHRAUBE ZUR BEFESTIGUNG TÜR- ZARGE MIT WAND - VIS DE FIXATION DORMANT DE PORTE		2	3.5x50	
HS59		SCREW FOR DOORSTEP - SCHRAUBEN FÜR SWELLE - VIS DE FIXATION DU SEUIL DE PORTE		3	3x30	
		SCREW FOR FIXING BOLT HINGE - SCHRAUBE FÜR TÜRRIGEL - - VIS DE FIXATION POUR CHARNIÈRES ET GONDS DE PORTE		16	4.5x25	
		SCREW FOR FIXING BOLT HINGE - SCHRAUBE FÜR TÜRRIGEL - - VIS DE FIXATION POUR CHARNIÈRES ET GONDS DE PORTE		12	4.5x35	
		SCREW FOR DOOR JAMB - SCHRAUBE FÜR TÜRRAHMEN - VIS DE FIXATION POUR MONTANT DE PORTE		2	4x60	
		SCREW FOR DOOR JAMB - SCHRAUBE FÜR TÜRRAHMEN - VIS DE FIXATION POUR MONTANT DE PORTE		2	5x90	

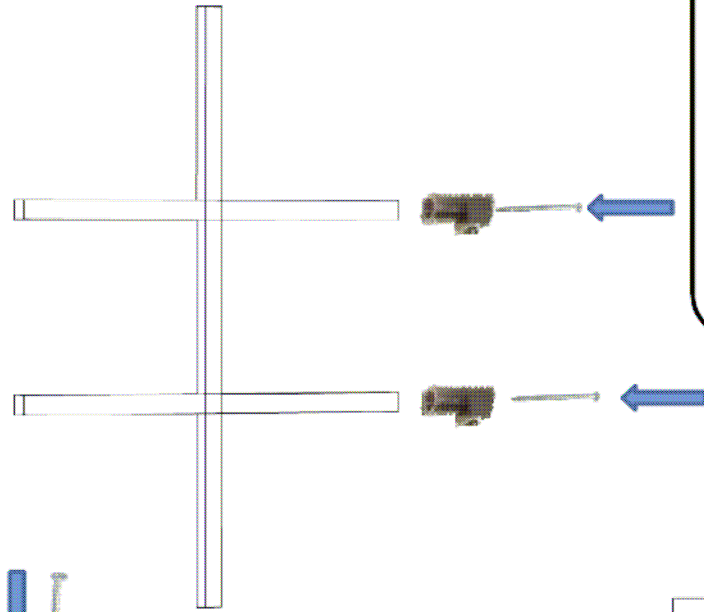
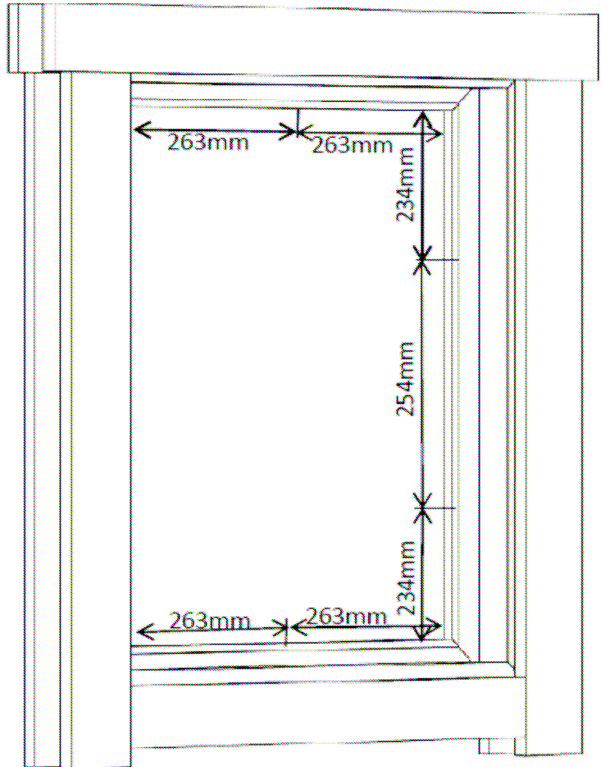
Pos	18.10.2013	Piecelist - Stücklist - Liste des composants Art.Nr. 344399	5/5	Q.	P. (mm)	L. (mm)
		SCREW FOR FILLET - SCHRAUBE ZUR BEFESTIGUNG TÜRLEISTE - - VIS D'ASSEMBLAGE DU CADRE DE PORTE		5	3x30	
		DOOR HANDLE FITTINGS-TÜRGRIF - SET DE GARNITURES DE SERRURE DE PORTE		1		
		NAILS FOR WINDOW/DOOR CROSS SLOT STRAIGHT - NÄGEL FÜR FENSTER/TÜREN EINSENWAREN - POINTE POUR QUINCAILLERIE DE PORTES ET FENETRES		48	1.4x30	
		WINDOW/DOOR CROSS SLOT STRAIGHT (PLASTIC) - FENSTER/TÜREN EINSENWAREN - QUINCAILLERIE POUR PORTES ET FENETRES		24		
		BOLT FOR WINDOW HANDLE FITTINGS - BOLZEN FÜR FENSTERGRIF BESCHLAG - BOULON POUR POIGNÉE D'OUVERTURE DE FENETRE		4		
		LATCH BOLT FÜR DOUBLE DOOR - TORRIEGEL - LOQUET POUR DOUBLE PORTE		2		
		MALE BOLT HINGE FOR DOOR - TÜRRIEGEL - PARTIE MALE DE CHARNIERE DE PORTE		4		
		DOOR HANDLE FITTINGS-TÜRGRIF - GARNITURE DE POIGNÉE DE PORTE		1		
		CYLINDER - ZYLINDERSCHLOSS - CYLINDRE DE SERRURE		1		
		HAMMER BLOCK - SCHLAGHOLZ - CALLE DE FRAPPE		1		
		WINDOW - FENSTER - FENETRE 685x882		AK.1.106.SSP.Pd	1	
		WINDOW - FENSTER - FENETRE 685x882		AK.1.106.SSV.Pd	1	
		DOOR - TÜR - PORTE 1494x1850		TUK.2.056.SVP.MXPG34	1	

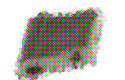
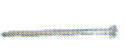

-  -6pcs
-  -6pcs
-  -12pcs

