

Domeo 7
Art. Nr. 4426619
1/8

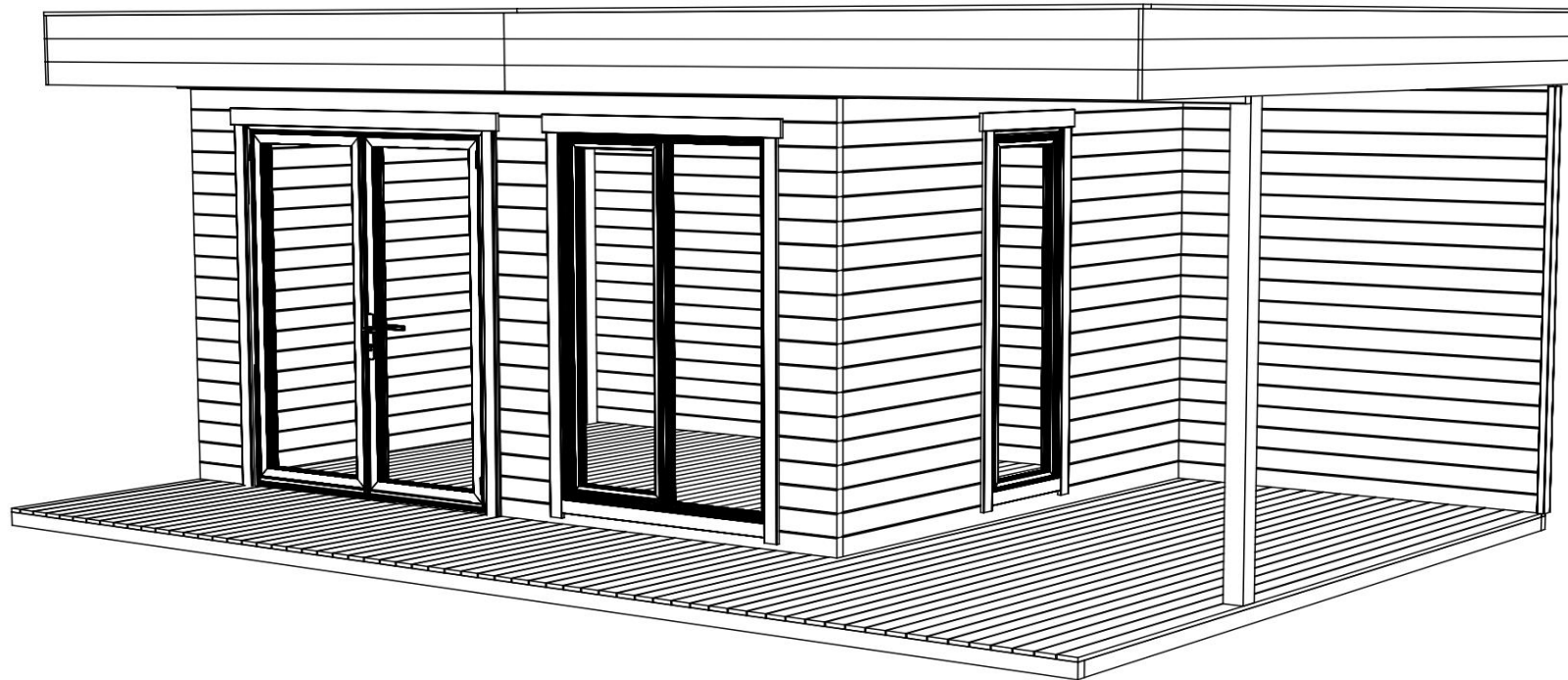

Art. Nr. 4426619

Grundplan - Grundplan - Plan de masse -
Planimetria - Plattegrond - Põhiplaan

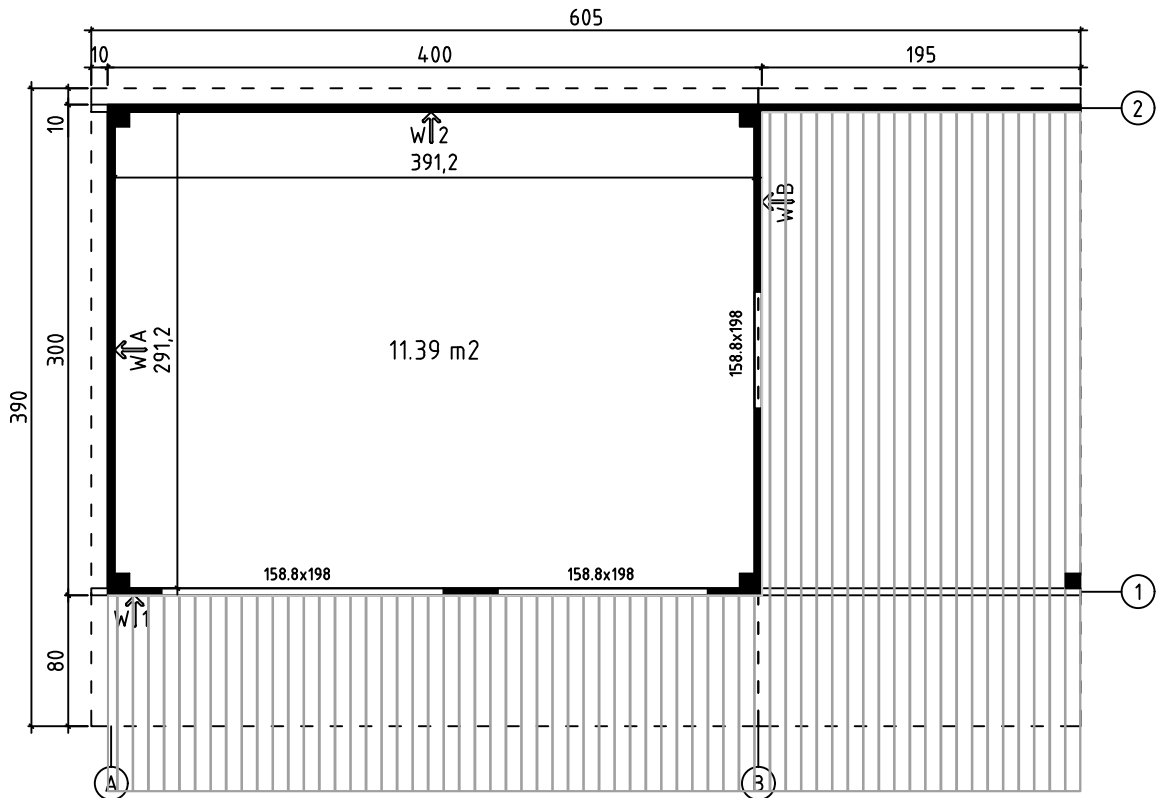

Foundation - Fundament - Fondation - Fondamenta - Fundering -
Immutatud alusraam

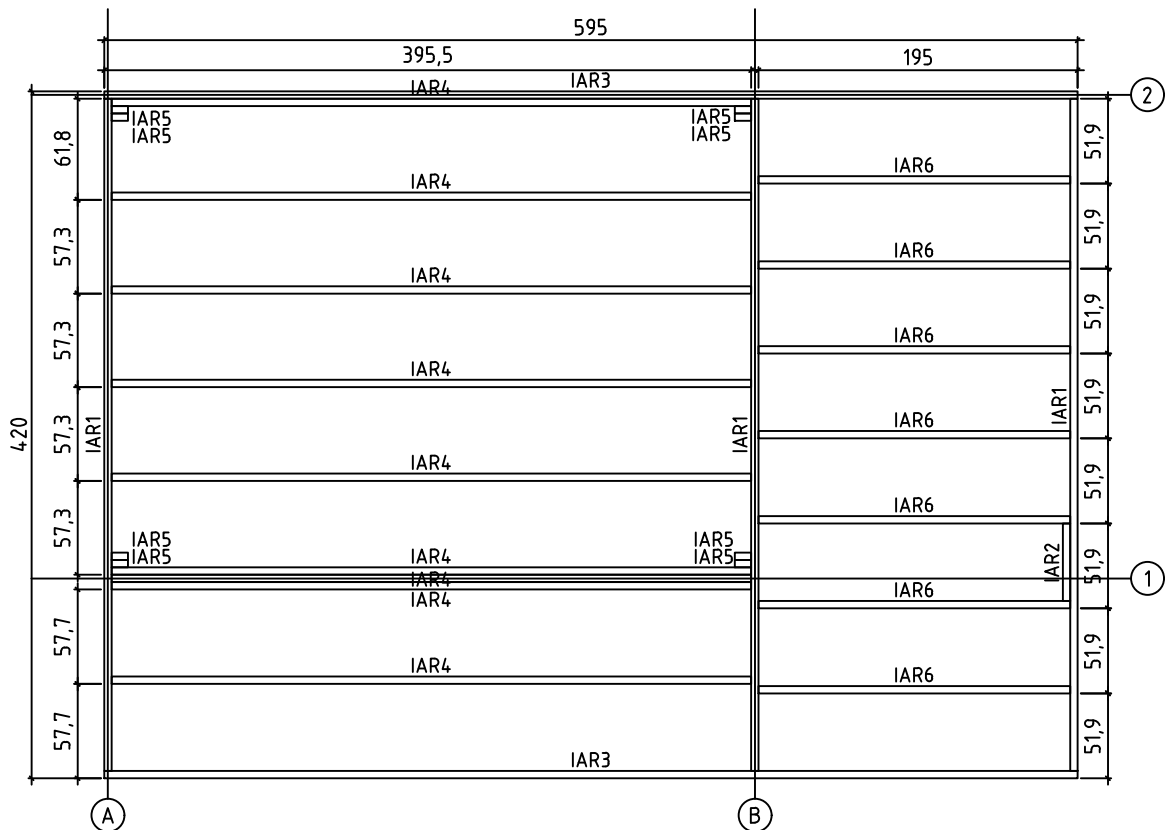

Art. Nr. 4426619

Floor boards - Fussbodenbretter - Plan pose plancher - Pavimento -
Vloerhout - Põrandalaudis

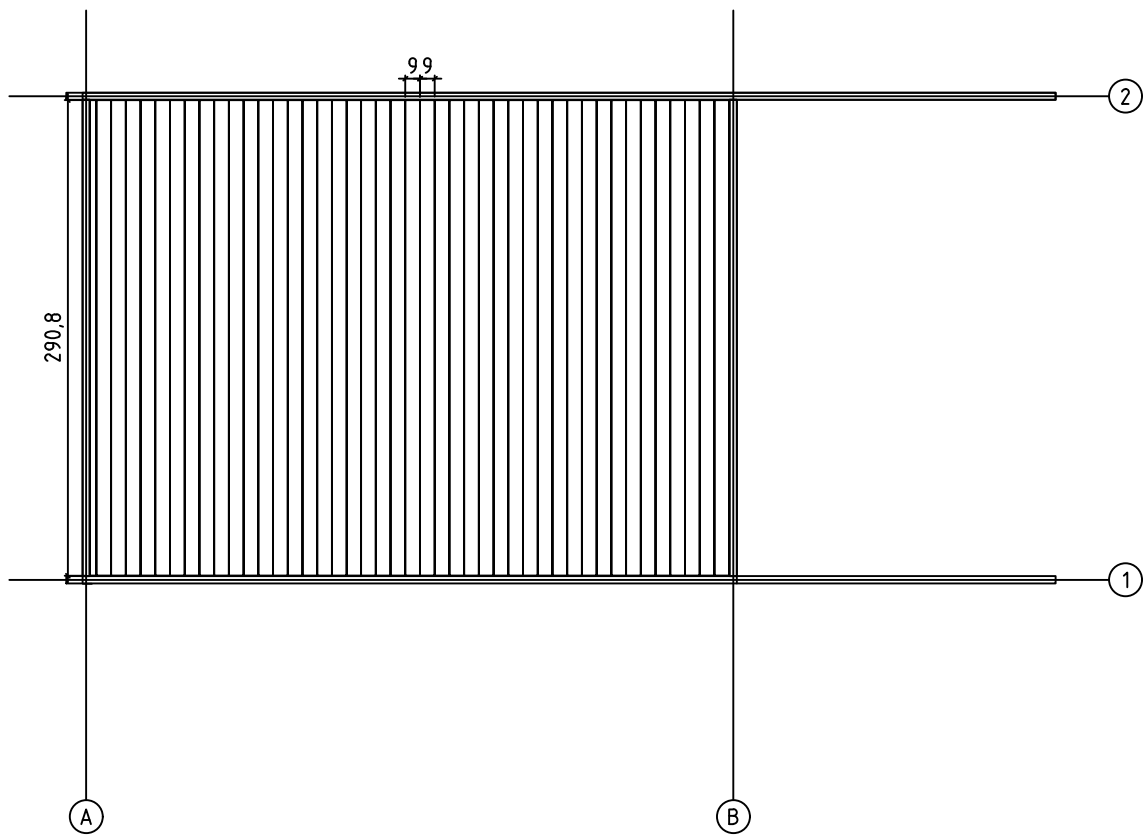



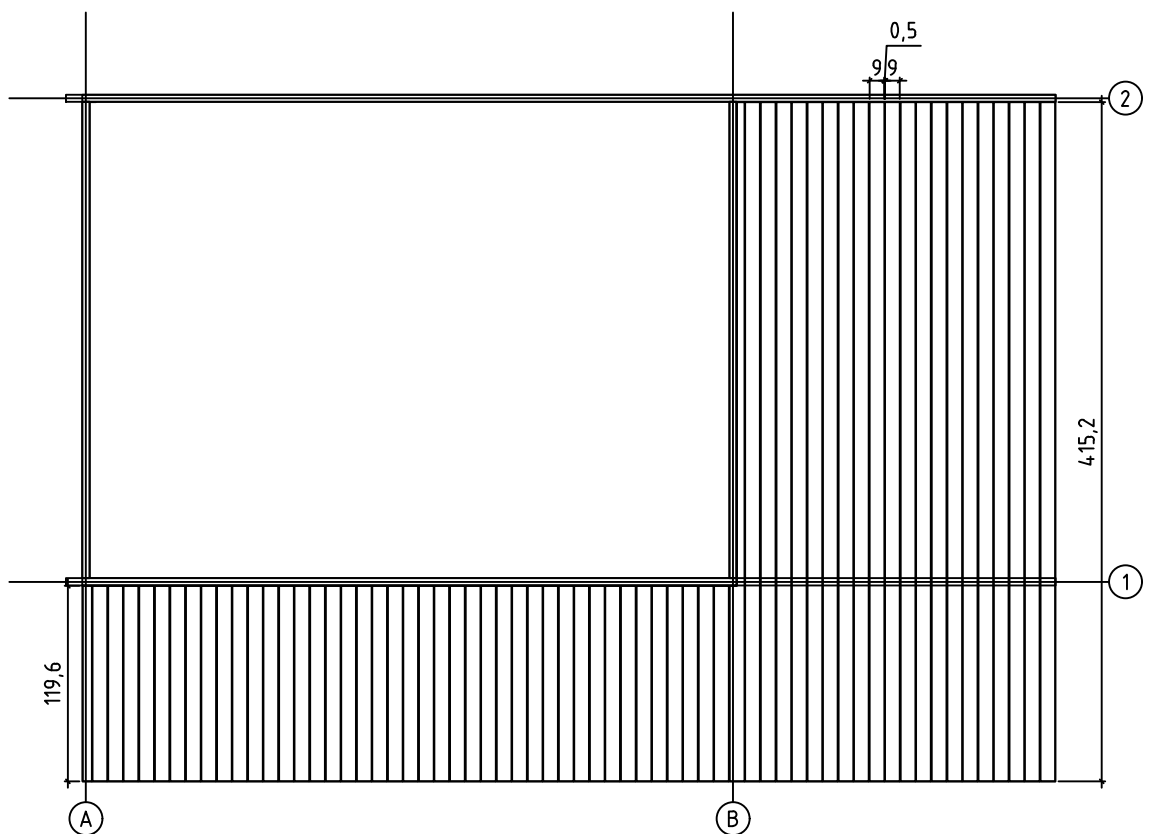

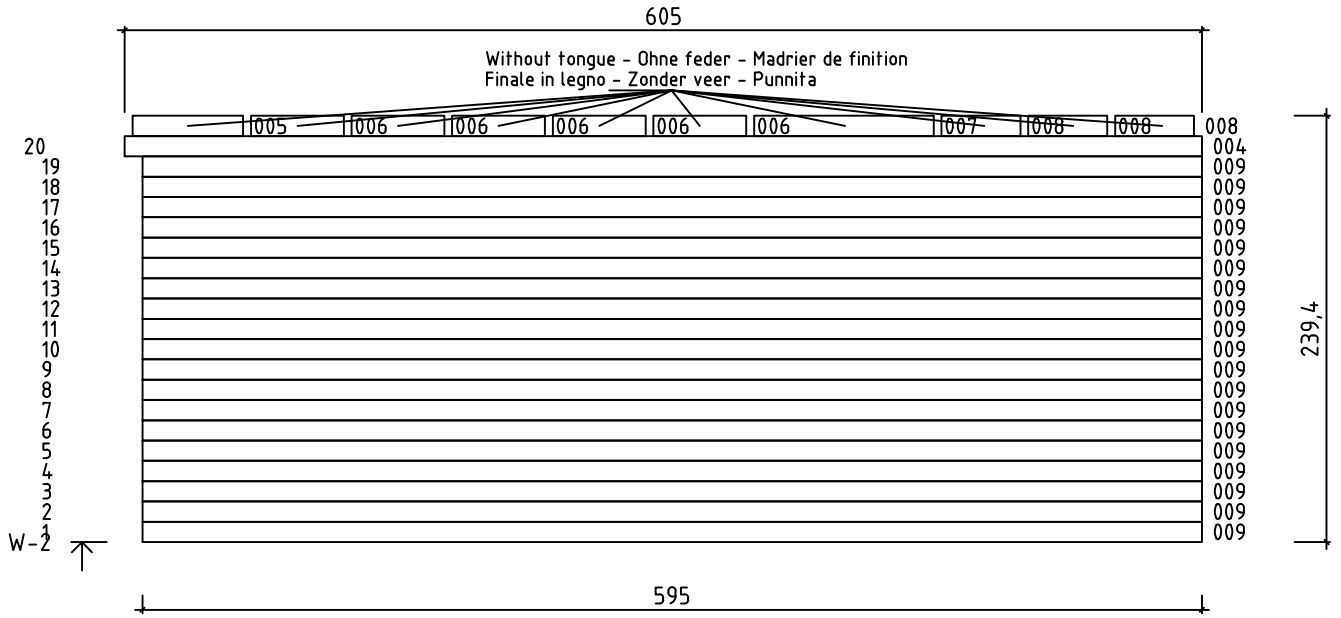
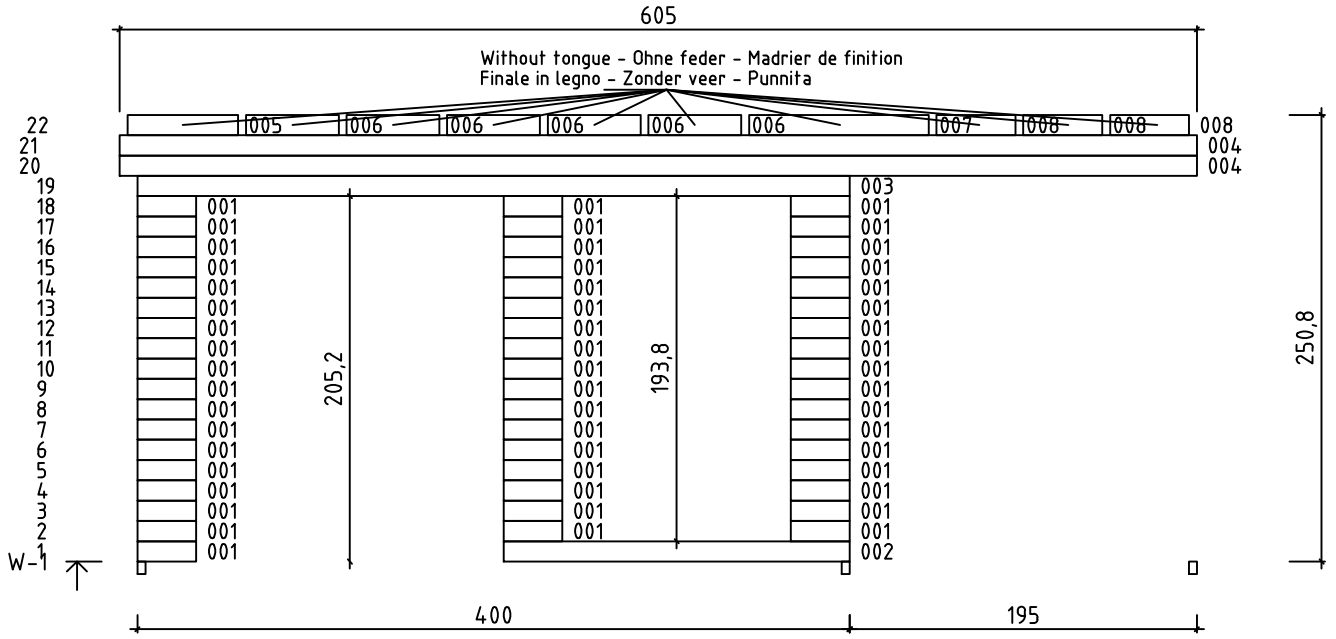

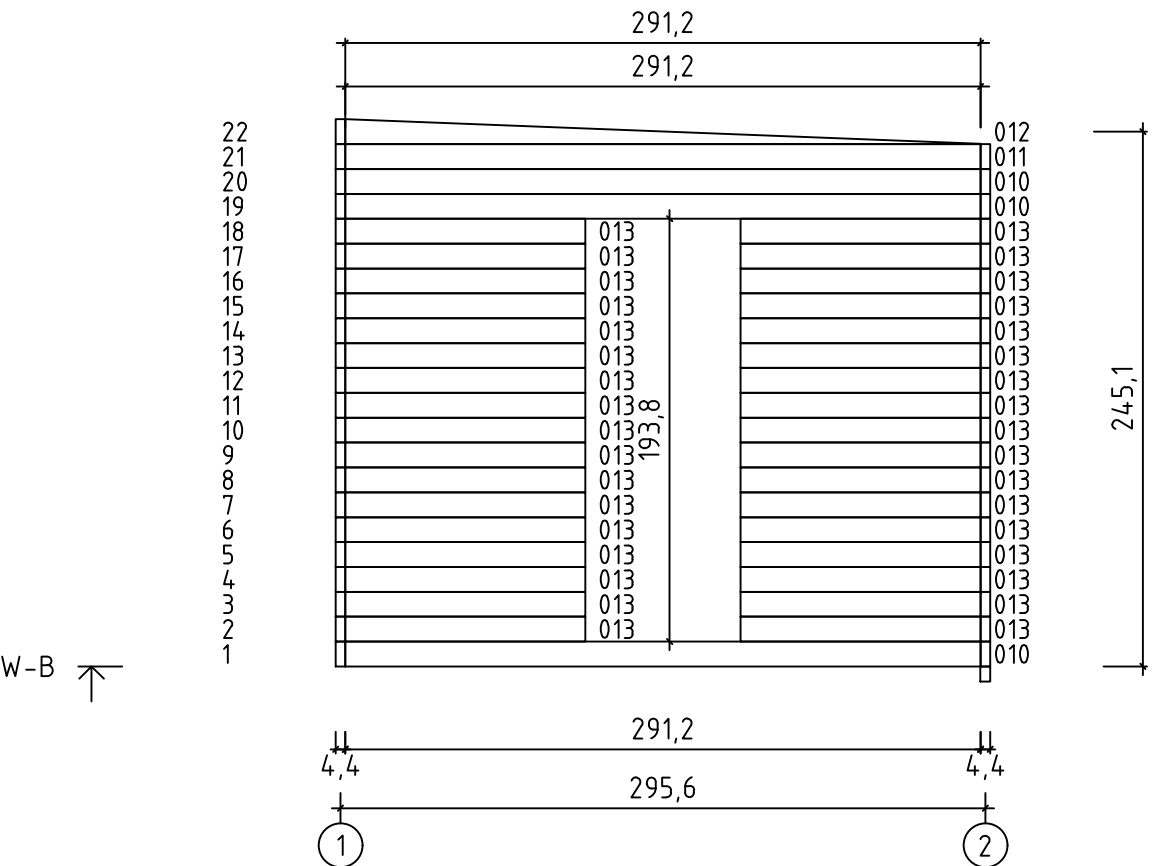
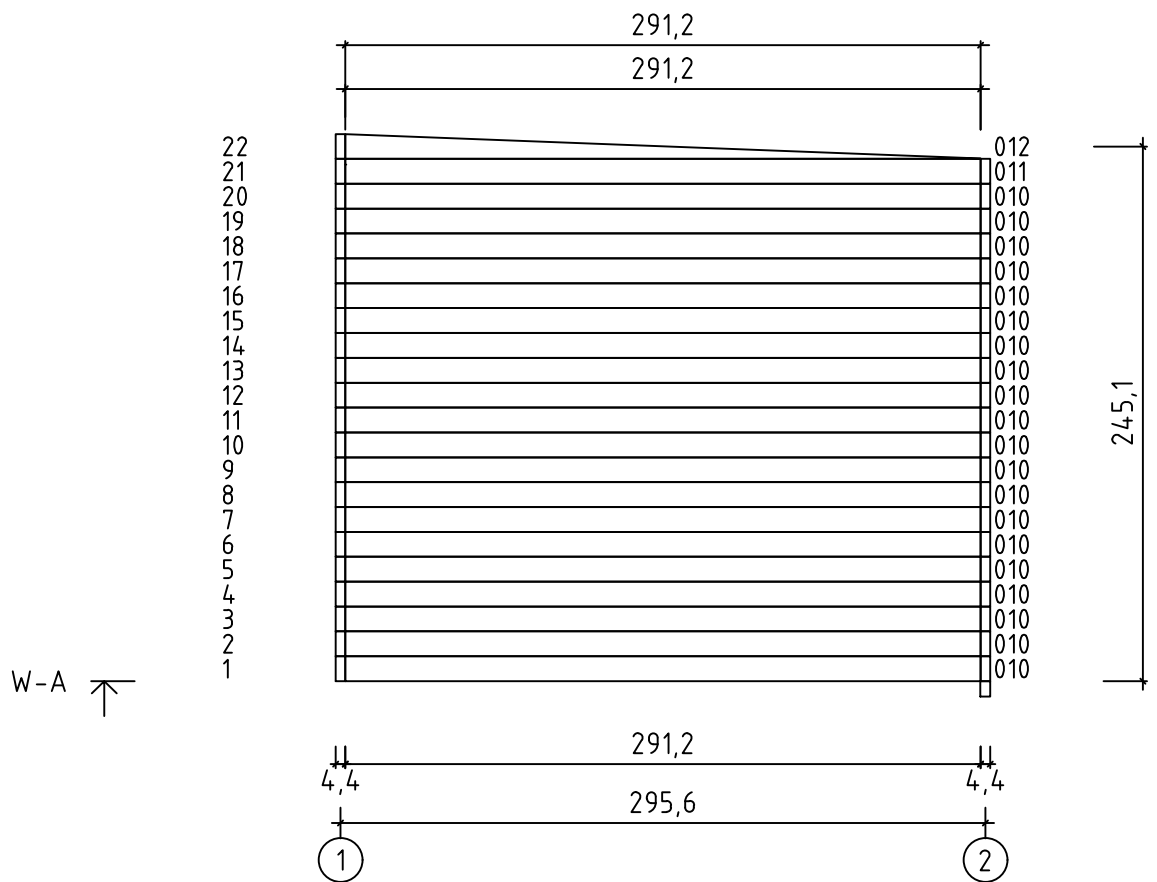

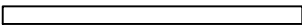
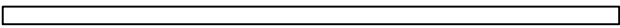
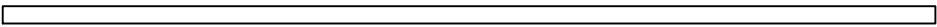

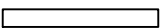
Terrace boards - Terrassenbretter - Plancher de terrasse -
Piattaforme terrazzo - Terrasvloer - Terrasilaudis

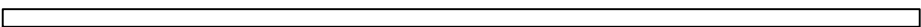
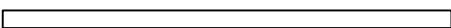

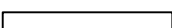
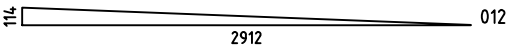
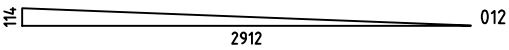
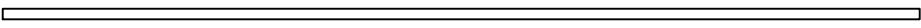
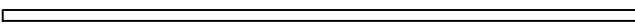
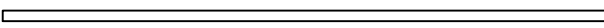
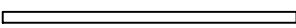

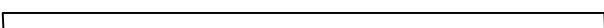

Pos	21.12.2020 Piece list - Stückliste - Liste des pièces - Elementi - Stuklijst - Tükítabel Art. Nr. 4426619 6/8	Arv	Profiil (mm)	Pikkus (mm)
001		52	44x114	330
002		1	44x114	1944
003		1	44x114	4000
004		3	44x114	6050
005		2	44x114	621
006		10	44x114	521
007		2	44x114	1009
008		6	44x114	443
009		19	44x114	5950
010		23	44x114	2912
011		2	44x114	2912
013		34	44x114	1100
WA-1		1		
WB-1		1		
IAR3	Foundation - Fundament - Fondation - Fondamenta - Fundering - Immutatud alusraam 	2	45x70	5950
IAR1	Foundation - Fundament - Fondation - Fondamenta - Fundering - Immutatud alusraam 	3	45x70	4110
IAR4	Foundation - Fundament - Fondation - Fondamenta - Fundering - Immutatud alusraam 	9	45x70	3910
IAR6	Foundation - Fundament - Fondation - Fondamenta - Fundering - Immutatud alusraam 	7	45x70	1905
IAR2	Foundation - Fundament - Fondation - Fondamenta - Fundering - Immutatud alusraam 	1	45x70	474
IAR5	Foundation - Fundament - Fondation - Fondamenta - Fundering - Immutatud alusraam 	8	45x70	100
SR1	Roof beam - Dachbalken - Panne de toit - Perlina del tetto - Gordingen / dakbalk - Pärlin 	11	44x140	3908
	Floor boards - Fussbodenbretter - Lame de plancher - Pavimento - Vloerhout - Põrandalaud 	44	90x18	2908
	Terrace boards - Terrassenbretter - Plancher de terrasse - Piattaforme terrazzo - Terrasvloer - Terrassilaud 	21	90x19	4152

Pos	21.12.2020 Piece list - Stückliste - Liste des pièces - Elementi - Stuklijst - Tükítabel Art. Nr. 4426619 7/8	Arv	Profiil (mm)	Pikkus (mm)
	Terrace boards - Terrassenbretter - Plancher de terrasse - Piattaforme terrazzo - Terrasvloer - Terrassilaud 	42	90x19	1196
	Roof boards - Dachbretter - Voliges - Perlina per tetto - Dakhout - Katuselaud 	44+1	90x18	4078
	Roof boards - Dachbretter - Voliges - Perlina per tetto - Dakhout - Katuselaud 	44+1	90x18	1972
	Floor fillet - Fussbodenleiste - Corniere de finition du plancher - Finitura per pavimento (battisco pa) - Vloerafwerklijst - Põrandaliist 		18x18	14
	Roofing felt fillet - Dachpappenleiste - Baguette de fixation du feutre bitumeux - Asse per fissaggio guaina bituminosa - Afdeklijst asfaltpapier - Katusepapiilist 	2	18x58	3043
	Roofing felt fillet - Dachpappenleiste - Baguette de fixation du feutre bitumeux - Asse per fissaggio guaina bituminosa - Afdeklijst asfaltpapier - Katusepapiilist 	2	18x58	3922
	Covering moulding - Deckungsprofil - Profils de finition verticaux a fixer a l'exteurier du cadre de la porte - cornice di finitura - Afdek profiel - Lengipuu 	2	30x44	612
	Covering moulding - Deckungsprofil - Profils de finition verticaux a fixer a l'exteurier du cadre de la porte - cornice di finitura - Afdek profiel - Lengipuu 	2	30x44	1181
	Covering moulding - Deckungsprofil - Profils de finition verticaux a fixer a l'exteurier du cadre de la porte - cornice di finitura - Afdek profiel - Lengipuu 	2	30x44	1894
	Covering moulding - Deckungsprofil - Profils de finition verticaux a fixer a l'exteurier du cadre de la porte - cornice di finitura - Afdek profiel - Lengipuu 	2	30x44	1900
	Railing strip - Begrenzungsleiste - Rembarde - Sbarra - Afscheidingslijst - Piirdelaud 	2	18x70	600
	Railing strip - Begrenzungsleiste - Rembarde - Sbarra - Afscheidingslijst - Piirdelaud 	2	18x70	1171
	Railing strip - Begrenzungsleiste - Rembarde - Sbarra - Afscheidingslijst - Piirdelaud 	1	18x70	1624
	Railing strip - Begrenzungsleiste - Rembarde - Sbarra - Afscheidingslijst - Piirdelaud 	4	18x70	1923
	Railing strip - Begrenzungsleiste - Rembarde - Sbarra - Afscheidingslijst - Piirdelaud 	4	18x70	1927
	Railing strip - Begrenzungsleiste - Rembarde - Sbarra - Afscheidingslijst - Piirdelaud 	2	18x70	1975
	Railing strip - Begrenzungsleiste - Rembarde - Sbarra - Afscheidingslijst - Piirdelaud 	2	18x70	1980
	Railing strip - Begrenzungsleiste - Rembarde - Sbarra - Afscheidingslijst - Piirdelaud 	2	18x70	1998
	Railing strip - Begrenzungsleiste - Rembarde - Sbarra - Afscheidingslijst - Piirdelaud 	2	18x90	802
	Railing strip - Begrenzungsleiste - Rembarde - Sbarra - Afscheidingslijst - Piirdelaud 	2	18x90	1361
	Railing strip - Begrenzungsleiste - Rembarde - Sbarra - Afscheidingslijst - Piirdelaud 	2	18x90	1768
	Post - Pfosten - Poteau - Piede registrabile - Stijl - Post 	1	90x90	2327
	Post - Pfosten - Poteau - Piede registrabile - Stijl - Post 	2	90x90	2390

